



CLMD12 12 Channel DC Load Controller Module

User's Manual

Revision 1.5

Copyright ©2021 Carling Technologies, Inc.

60 Johnson Ave.
Plainville, CT 06062 USA
All Rights Reserved

<http://www.maretron.com>

Revision History

Revision	Description
1.0	Internal Review
1.1	Second Review
1.2	Initial Release
1.3	Updated Accessory Part Numbers
1.4	Removed requirement for parallel resistors for LED loads
1.5	Added ability to parallel breakers together for increased current

Table of Contents

1	Notices	1
2	Introduction	1
2.1	Firmware Revision	2
2.2	CLMD12 Features	2
2.3	Accessories	2
2.3.1	Connectors	2
2.3.2	Bypass Module	3
2.4	Quick Install	3
2.5	Theory of Operation	3
2.5.1	Electronic Circuit Breakers	4
2.5.1.1	Overcurrent protection	5
2.5.1.2	Output control circuit protection current limit	5
2.6	Load protection current limit	6
2.7	Pulse Width Modulation (PWM)	6
2.8	Paralleling Breakers	7
2.8.1	Discrete Inputs	7
3	Installation	8
3.1	Unpacking the Box	8
3.2	Choosing a Mounting Location	8
3.3	Mounting the CLMD12	8
3.4	Connecting the CLMD12	8
3.4.1	NMEA 2000® Connection	9
3.4.2	Breaker Connections	10
3.4.3	Discrete Input Connections	10
3.4.4	DC Power Connection	11
3.4.5	Checking Connections	11
3.5	Configuring the CLMD12	11
3.5.1	General Tab	11
3.5.1.1	Label	14
3.5.1.2	Instance	14
3.5.1.3	Input Voltage	15
3.5.1.4	Not Configured	15
3.5.1.5	Serial Number Invalid	15
3.5.1.6	Breaker # <i>n</i>	15
3.5.1.7	Flash Map	18
3.5.1.8	Discrete I/O	19
3.5.1.9	Inputs	21
3.5.1.10	Advanced	23
3.5.1.11	Installation Description	25
3.5.1.12	Control	26
4	Operation	28
4.1	Manual Breaker Control	28
4.2	Automatic Breaker Control by Flash Function	28
4.3	Automatic Breaker Control by Discrete I/O Function	28
4.4	Manual Bypass	29

5	Maintenance.....	30
6	Troubleshooting	31
7	Technical Specifications.....	33
8	Mechanical Drawing.....	35
9	Technical Support	36
10	Installation Template	37
11	Maretron (2 Year) Limited Warranty	38

Table of Figures

Figure 1 – Output Channel Schematic.....	5
Figure 2 – Discrete Input Impedance Model.....	8
Figure 3 – CLMD12 Side View	9
Figure 4 – NMEA 2000® Connector (J3) Face Views	9
Figure 5 – CLMD12 General Tab	14
Figure 6 – CLMD12 Flash Map Tab	18
Figure 7 – CLMD12 Discrete I/O Tab	20
Figure 8 – CLMD12 Inputs Tab	22
Figure 9 – CLMD12 Advanced Tab	24
Figure 10 – CLMD12 Installation Description Tab	26
Figure 11 – CLMD12 Control Tab.....	27
Figure 12 – Bypass Module Usage.....	30
Figure 13 – Mounting Surface Template.....	37

Table of Appendices

Appendix A – NMEA 2000® Interfacing.....	A1
--	----

1 Notices

All illustrations are for reference purposes only. Nothing contained in this document shall replace or modify the requirements of industry standards applicable to wire or other protection, including without limitation, those of the American Boat and Yacht Council (ABYC); the National Electric Code (NEC); and/or the National Fire Protection Association (NFPA). Failure to install the device or any components thereof in compliance with any such Industry Standard may limit the warranties made by Carling Technologies, Inc.



WARNING

- Removal of CLMD12 cover in the field will compromise the operation of the unit and voids warranties set forth by Carling Technologies.

2 Introduction

Congratulations on your purchase of the Maretron MPower CLMD12 12 Channel DC Load Controller Module. Carling has designed and built your CLMD12 to the highest standards for years of dependable and accurate service.

The Maretron CLMD12 contains 12 output channels implemented by direct current (DC) Electronic Circuit Breakers (ECB's), each capable of switching up to 5, 10, or 12 Amps, with a total current capacity of 75 Amps. In addition to fast switching, low-loss solid state ON/OFF switches, it provides accurate current measurement for each load along with short circuit protection.

The CLMD12 additionally contains 7 input channels implemented by DC digital inputs, programmable to sense whether the input is connected to a high level, connected to a low level, or left unconnected.

The CLMD12 connects directly to an NMEA 2000® network, so you can turn on and off the breakers from a Maretron DSM-Series display or any device running Maretron N2KView® software, such as TSM-Series multifunction displays or MBB-Series black boxes. Additionally, since the CLMD12 supports standard NMEA 2000® messages for control, it can be controlled by any NMEA 2000® device supporting those messages. The CLMD12 easily handles resistive DC loads like lights or inductive DC loads like pumps and motors. The CLMD12 can also be used to switch AC circuits using external relays. An added benefit of the CLMD12 is that it reports the current through each of the 12 breakers. This allows you to determine if loads are drawing too little electrical current such as burnt-out bulbs, or if the loads are starting to draw too much electrical current.

The Maretron CLMD12 is designed to operate within the harsh demands of the marine environment. However, no piece of marine electronic equipment can function properly unless installed, configured, and maintained in the correct manner. Please read carefully and follow

CLMD12 User's Manual

these instructions for installation, configuration, and usage of the Maretron CLMD12 in order to ensure optimal performance.

2.1 Firmware Revision

This manual corresponds to CLMD12 firmware revision 1.14.

2.2 CLMD12 Features

The Maretron CLMD12 has the following features.

- NMEA 2000® Interface
- Waterproof Connectors
- Sealed Waterproof Enclosure
- Opto-Isolated from NMEA 2000® Eliminating Potential Ground Loops
- Twelve (12) Electronic Circuit Breakers (ECB's) for On / Off Control Over NMEA 2000® Network
- Each breaker Capable of Carrying Up to 5, 10, or 12 Amps
- Individual Breaker Electrical Current Monitoring
- Breakers can have power-up states defined (ON, OFF, or Previous states)
- Breakers can be locked against inadvertent actuation
- Seven (7) discrete inputs configurable as Active High, Active Low.
- Automatic ECB Overcurrent Shutdown
- Automatic ECB Thermal Shutdown (Overtemperature Protection)

2.3 Accessories

This section lists the accessories which are available for the CLMD12.

2.3.1 Connectors

There are two options for connecting the CLMD12 to the input and output channels:

Option 1: Connect by assembling connectors to existing wires (this option requires a Deutsch HDT-48-00 crimp tool)

Description	Part Number	Quantity Required
J1 (Output) Mating connector	Deutsch DT06-12SA	1
J1 (Output) Socket	Deutsch 0462-209-16141 (14 AWG)	12
J1 (Output) Wedge	Deutsch W12S	1
J2 (Input) Mating connector	Deutsch DT06-08SA-E003	1
J2 (Input) Socket	Deutsch 0462-201-16141 (16 – 20 AWG)	8
J2 (Input) Wedge	Deutsch W8S	1

Option 2: Connect by splicing flying leads on pre-assembled connectors to existing wires (this option does not require any specialized tools)

Description	Part Number	Quantity Required
Output (J1) Mating Connector with 12" flying leads	A3706	1
Input (J2) Mating Connector with 12" flying leads	A3707	1

2.3.2 Bypass Module

The loads controlled by the CLMD12 may be connected to a bypass module in the event of communication loss or other malfunction. Please refer to section 4.4 for details.

Description	Part Number	Quantity Required
MPower 12 Channel DC Bypass Module	CBMD12	1

2.4 Quick Install

Installing the Maretron CLMD12 involves the following steps. Please refer to the individual sections for additional details.

1. Unpack the box (Section 3.1)
2. Choose a mounting location (Section 3.2)
3. Mount the CLMD12 (Section 3.3)
4. Connect the CLMD12 (Section 3.4)
5. Configure the CLMD12 (Section 3.5)

2.5 Theory of Operation

The CLMD12 provides the ability to turn on or off DC power to a load circuit using 12 independent solid-state Electronic Circuit Breakers (ECB's). Each breaker contains protection against overcurrent, overtemperature, and short circuit.

Each breaker in the CLMD12 may be manually switched on or off using any of the following methods:

- 1) Maretron N2KView® software running on a personal computer, or
- 2) Maretron N2KView® software running on a Maretron MBB-Series Black Box for Vessel Monitoring and Control, or
- 3) Maretron N2KView® software running on a Maretron TSM-Series Vessel Monitoring and Control Touchscreen Computer, or
- 4) Maretron N2KView® Mobile app running on an Android or iOS tablet or phone, or
- 5) a Maretron DSM-Series NMEA 2000® Multi-function Color Graphic Display, or

- 6) any NMEA 2000®-connected switch, such as an Maretron MPower CKM-Series network-connected keypad or VMM-Series network-connected switches, or
- 7) any NMEA 2000® product that can transmit standard NMEA 2000® control messages (please refer to Appendix A for details).

The breakers can be monitored and/or controlled through use of the Breaker/Switch component in the Electrical Distribution category of the Maretron display products listed above. In addition, the current through each breaker may be monitored through the Breaker/Switch Current component in the Electrical Distribution category of Maretron display products.

Since the output channels are implemented by Electronic Circuit Breakers, if the NMEA 2000 power is removed, all breakers will revert to the open (OFF) state. The state that the breaker will be in when the NMEA 2000 power is restored can be configured to be ON, OFF, or in the last state the breaker was in before power was removed.

2.5.1 Electronic Circuit Breakers

The 12 high-side output channels are switched with MOSFETs connected in a back-to-back arrangement so that back-feeding is not possible when the breaker is turned off.

All output channels employ the following:

- Latched shutdown overcurrent detection with reset
- Overcurrent surge allowance that prevents overcurrent latch tripping when starting high surge loads such as incandescent lamps

The table below shows the connection and maximum current capacity for each ECB.

J1 Connector Pin No.	Description	Max Output AMPS
1	Breaker #5	10
2	Breaker #4	12
3	Breaker #8	10
4	Breaker #2	10
5	Breaker #10	10
6	Breaker #1	10
7	Breaker #11	10
8	Breaker #3	5
9	Breaker #12	5
10	Breaker #6	5
11	Breaker #9	5
12	Breaker #7	12

Figure 1 below shows the schematic of each breaker in the CLMD12.

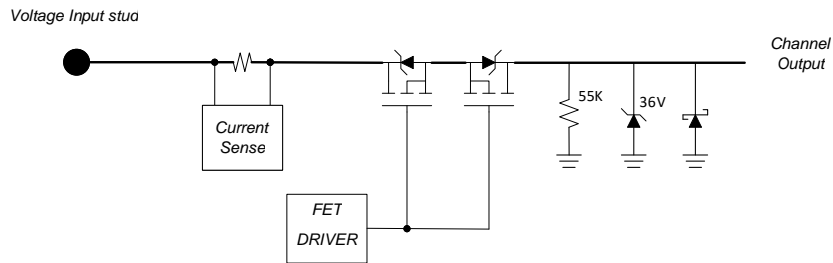

Figure 1 – Output Channel Schematic

2.5.1.1 Overcurrent protection

The overcurrent protection has two purposes: to protect the CLMD12 and to protect the load circuits. The CLMD12 is protected by fast acting overcurrent latches in hardware that allow for overcurrent conditions that will not damage the output control circuit. Load protection is implemented in software and trip levels and delays are set in configuration (please refer to Section 3.5.1.6 for details).

When an overcurrent condition is detected, the CLMD12 will latch the breaker off for the remainder of the continuously powered interval unless commanded OFF and then ON again through the NMEA 2000 interface.

2.5.1.2 Output control circuit protection current limit

The non-configurable output control circuit protection allows surge currents to occur without tripping the overcurrent shutdown function. These surges are allowed any time the breaker is ON according to a single time constant characteristic. Over-current levels are allowed for a time that is inversely proportional to the magnitude of overcurrent according to a well-defined curve that is tailored to prevent damage to the CLMD12. This protection cannot be disabled and will trip instantaneously when a peak limit is exceeded. Continuous load currents above the hard current limit will also trip the overcurrent latch.

Breaker factory current rating	Peak Current Limit	Hard Current Limit
5A	70A	7.5A
10A	140A	12A
12A	156A	20A

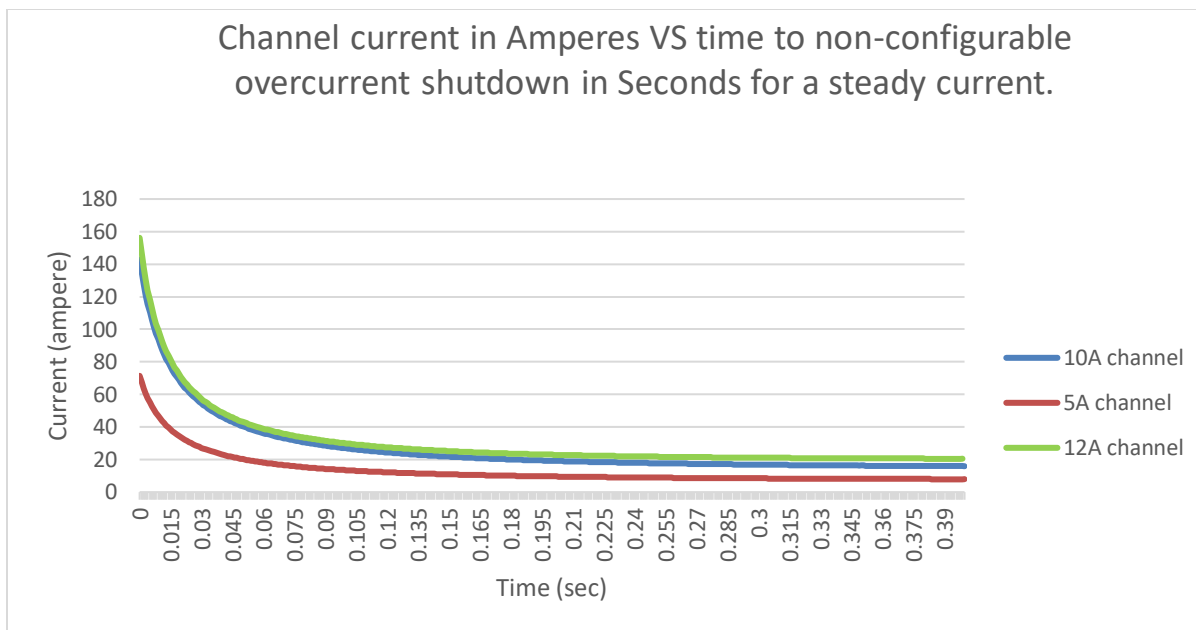

2.6 Load protection current limit

The configurable load protection current limit provides three parameters to customize the overcurrent protection of the load.

- Current rating: Constant load current above this level will trip the breaker OFF.
- Inrush Delay: An adjustable delay (0 to 1500 milliseconds) that starts at the time of breaker turn ON. The configurable current limit trip is blocked during this period.
- Trip Delay: An adjustable delay (0 to 750 milliseconds) that starts when currents exceeding the current rating setting are detected after the Inrush Delay has expired. The configurable current limit trip is blocked during this period.

2.7 Pulse Width Modulation (PWM)

Breakers can be operated in pulse width modulation (PWM) mode, also referred to as dimming, to control the brightness of incandescent or LED lighting. The breaker may be configured with a duty cycle of 5% to 100% with a resolution of 1%.



WARNING

- The breaker being used as a dimming module will provide an active high output at full battery voltage to the LED control module. Verify that the LED control module can accept this type of input prior to use. When a breaker is configured to provide a PWM output (dimming), the PWM frequency is 200Hz, and the output current of the breaker is limited to 3.0A. Use of a breaker in a PWM mode (duty cycle less than 100%) for control of motors or other inductive loads is prohibited.

2.8 Paralleling Breakers

Breakers can be paralleled for higher current capacity:

- Only parallel two breakers with the same current rating.
- Wiring recommendation: Run two breakers wired together with matched impedance.
- Please note that the maximum current rating when two breakers are paralleled is typically 180% of the single channel rating. (Example: 18A maximum for two 10A breakers in parallel). This is because the impedance of the two paralleled breakers will not be identical due to component variation.
- See tables below for recommended parallel breakers:

Paralleled Breakers	Typical Maximum Current
Breaker #7 (12A) & Breaker #4 (12A)	22A
Breaker #9 (5A) & Breaker #6 (5A)	9A
Breaker #6 (5A) & Breaker #12 (5A)	9A
Breaker #3 (5A) & Breaker #12 (5A)	9A
Breaker #5 (10A) & Breaker #8 (10A)	18A
Breaker #2 (10A) & Breaker #8 (10A)	18A
Breaker #2 (10A) & Breaker #10 (10A)	18A
Breaker #1 (10A) & Breaker #10 (10A)	18A

You can parallel two breakers by assigning the same switch group number to the two breakers.

When you parallel breakers, configure the CLMD12 to assign 50% of the maximum current to the Current Rating parameter for each of the two paralleled breakers. For example, if you parallel Breaker #7 and Breaker #4 and wish to use them to supply power to a load rated at 22A, configure the Current Rating for each of the two breakers to 12A. This will result in a typical maximum current rating of 22A for the paralleled breakers.

2.8.1 Discrete Inputs

The discrete inputs respond to three voltage level states, “Active High”, “Open” and “Active Low”. That is, when the input is at V-Battery it will be read as a logic ‘1’ or “High”. When the input is at 0 V or GND it will be read as logic ‘0’ or “Low”. The unused discrete inputs can be left disconnected which results in an “open” state.

The following diagram shows the impedance model of the Discrete Input circuits.

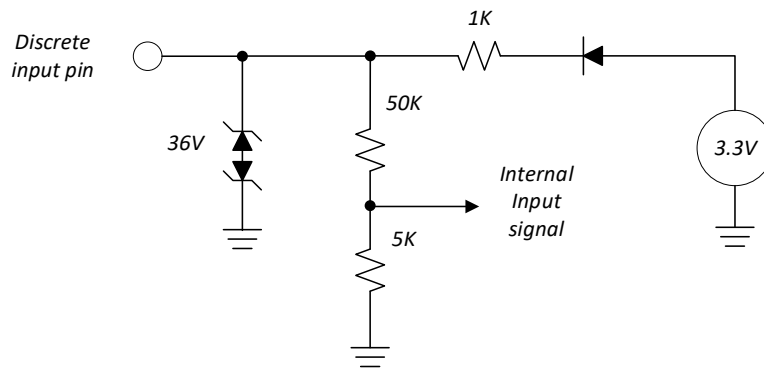

Figure 2 – Discrete Input Impedance Model

Each discrete input can be configured to output an ON indication when the input voltage level is sensed as Low, High, or Both (Low and High). If the input voltage level is not one of the configured levels, then the discrete input channel will output an OFF indication.

3 Installation

3.1 Unpacking the Box

When unpacking the box containing the Maretron CLMD12, you should find the following items:

- 1 – CLMD12 – 12 Channel DC Load Controller Module
- 1 – CLMD12 User's Manual
- 1 – Warranty Registration Card

If any of these items are missing or damaged, please contact Carling.

3.2 Choosing a Mounting Location

Please consider the following when choosing a mounting location.

1. The CLMD12 is waterproof, so it can be mounted in a damp or dry location.
2. The orientation is not important, so the CLMD12 can be mounted on a horizontal deck, vertical bulkhead, or upside down if desired.
3. The CLMD12 is temperature-rated to 85°C (185°F), so it should be mounted away from engines or engine rooms where the operating temperature exceeds the specified limit.

3.3 Mounting the CLMD12

Attach the CLMD12 securely to the vessel using mounting screws or other fasteners through the three provided mounting holes. Do not use threadlocking compounds containing methacrylate ester, such as Loctite Red (271), as they will cause stress cracking of the plastic enclosure.

3.4 Connecting the CLMD12

The CLMD12 requires four types of electrical connections, as shown in Figure 3 below:

- 1) the NMEA 2000® connection (J3), which is described in Section 3.4.1,

- 2) the output channel (breaker) connections (J1), which are described in Section 3.4.2,
- 3) the discrete input signal connections (J2), which are described in Section 3.4.3, and
- 4) the DC power connection stud, which is described in Section 3.4.4.

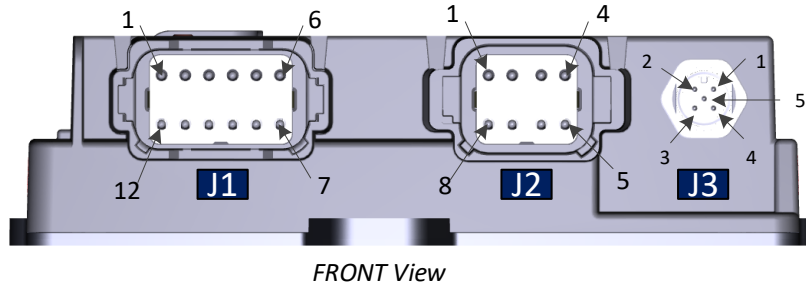

Figure 3 – CLMD12 Side View

3.4.1 NMEA 2000® Connection

The NMEA 2000® connector can be found on the side of the enclosure and labeled “J3”. The NMEA 2000® connector is a round five-pin male connector (see Figure 4). You connect the CLMD12 to an NMEA 2000® network using a Maretron NMEA 2000® cable (or compatible cable) by connecting the female end of the cable to the CLMD12 (note the key on the male connector and keyway on the female connector). Be sure the cable is connected securely and that the collar on the cable connector is tightened firmly. Connect the other end of the cable (male) to the NMEA 2000® network in the same manner. The CLMD12 is designed such that you can plug or unplug it from an NMEA 2000® network while the power to the network is connected or disconnected. Please follow recommended practices for installing NMEA 2000® network products.

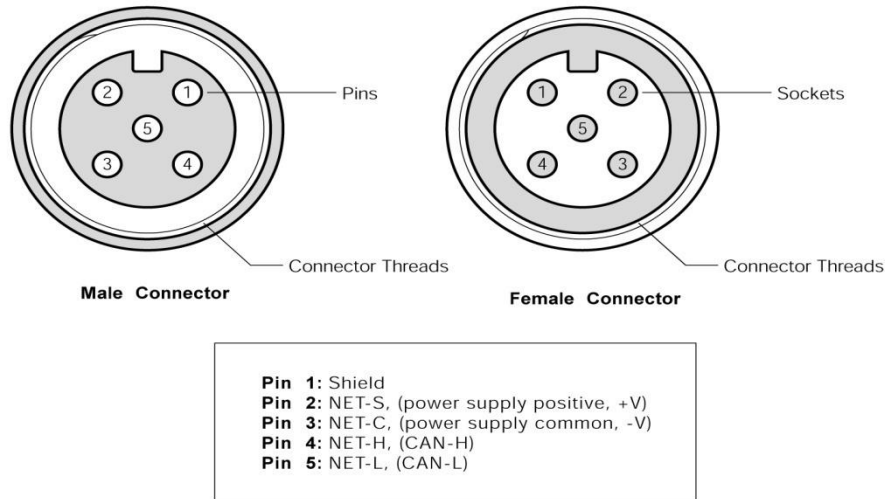

Figure 4 – NMEA 2000® Connector (J3) Face Views

3.4.2 Breaker Connections

The CLMD12 breaker connections are made by connecting to the 12-pin J1 connector. The pin number on the J1 connector corresponds to a breaker number, which is represented as an indicator number in the 127501 Binary Status Report message or as a Connection ID in the 127500 Load Controller Connection & State message. The correspondence of the J1 connector pin number to the channel number is detailed in the table below, along with the maximum current supported by the channel.

J1 Connector Pin No.	Description	NMEA 2000 PGN 127501 Indicator Number	NMEA 2000 PGN 127500 Connection ID	Max Output AMPS
1	Breaker #5	5	4	10
2	Breaker #4	4	3	12
3	Breaker #8	8	7	10
4	Breaker #2	2	1	10
5	Breaker #10	10	9	10
6	Breaker #1	1	0	10
7	Breaker #11	11	10	10
8	Breaker #3	3	2	5
9	Breaker #12	12	11	5
10	Breaker #6	6	5	5
11	Breaker #9	9	8	5
12	Breaker #7	7	6	12

3.4.3 Discrete Input Connections

Connect each discrete input channel to a pin on the J2 connector as shown in the table below. Each connection may switch between open circuit and system ground or the supply voltage.

J2 Connector Pin No.	Description	NMEA 2000 PGN 127501 Indicator Number
1	Discrete Input #3 (active high/open/active low)	15
2	Discrete Input #1 (active high/open/active low)	13
3	Discrete Input #7 (active high/open/active low)	19
4	Discrete Input #5 (active high/open/active low)	17
5	Discrete Input #6 (active high/open/active low)	18
6	System Ground	N/A
7	Discrete Input #2 (active high/open/active low)	14
8	Discrete Input #4 (active high/open/active low)	16

**WARNING**

The System Ground signal (Connector J2, Pin 6) must be connected to the supply voltage ground reference for proper system operation, regardless of whether any of the Discrete Input signals are connected.

3.4.4 DC Power Connection

Connect a source of DC power with a ring terminal to the 1/4"-20 stud on the top of the device, being careful not to torque the connection beyond the specified value of 20 in-lbs. (2.26 N·m). Ensure that the cable providing the DC power is protected by a fuse or circuit breaker with a value appropriate to protecting the wire or the 75A maximum specification of the CLMD12, whichever is less.

3.4.5 Checking Connections

Once all of the connections to the CLMD12 have been completed, check to see that information is being properly transmitted by observing an appropriate NMEA 2000® display. If you don't see channel on/off status, refer to Section 6, "Troubleshooting".

3.5 Configuring the CLMD12

The CLMD12 will transmit data over the NMEA 2000® network as it is shipped from the factory; however, it may require configuration, depending on the type of switches monitored and the number of similar products on the NMEA 2000® network. There are several configurable items within the CLMD12, which are detailed in the remainder of this section.

You configure the CLMD12 using Maretron N2KAnalyzer® or Carling G2Analyzer software. The following subsections describe the configurable parameters in the CLMD12.

3.5.1 General Tab

This tab contains commonly-used configuration items.

CLMD12 User's Manual

CLMD12 (0x93) 1671549 - Configuration Dialog

General | Flash Map | Discrete I/O | Inputs | Advanced | Installation Description | Control

Label (Max. 32 Characters): **CLMD12** Instance: 1

Input Voltage: 12 VDC Not Configured Serial Number Invalid

Breaker #1

Label: **Dry Bilge Pump** Trip Delay: 200 ms Factory Current Rating: 10 A
State: OFF Inrush Delay: 500 ms Current Rating: 2 A
Default State: OFF Default Dim Value: 100 % Current: 0 A
Default Lock State: Unlocked Current Dim Value: 100 % Voltage: 0 V
Sound Alarm When Tripped: Dimming Allowed: Flash Map: 0
ECB Model: 0 Combine With: **Breaker #2** User Config Allowed:

Status

Short Load Breaker Locked
 Breaker Tripped
 Breaker ON Communications Error
 Open Load Breaker Communicating

Breaker #2

Label: **CLMD12 Breaker 02** Trip Delay: 200 ms Factory Current Rating: 10 A
State: OFF Inrush Delay: 500 ms Current Rating: 2 A
Default State: OFF Default Dim Value: 100 % Current: 0 A
Default Lock State: Unlocked Current Dim Value: 100 % Voltage: 0 V

Load Config From File... Save Config To File... Restore Factory Defaults
Get Config From Device Put Config To Device Close

RED text indicates a changed parameter that has not yet been put to the device

CLMD12 (0x93) 1671549 - Configuration Dialog

General | Flash Map | Discrete I/O | Inputs | Advanced | Installation Description | Control

Label (Max. 32 Characters): **CLMD12** Instance: 1

Input Voltage: 12 VDC Not Configured Serial Number Invalid

Breaker #1

Label: Dry Bilge Pump Trip Delay: 200 ms Factory Current Rating: 10 A
 State: OFF Inrush Delay: 500 ms Current Rating: 2 A
 Default State: OFF Default Dim Value: 100 % Current: 0 A
 Default Lock State: Unlocked Current Dim Value: 100 % Voltage: 0 V
 Sound Alarm When Tripped: Dimming Allowed: Flash Map: 0
 ECB Model: 0 Combine With: Breaker #2 User Config Allowed:

Status

Short Load Breaker Locked
 Breaker Tripped
 Breaker ON Communications Error
 Open Load Breaker Communicating

Breaker #2

Label: CLMD12 Breaker 02 Trip Delay: 200 ms Factory Current Rating: 10 A
 State: OFF Inrush Delay: 500 ms Current Rating: 2 A
 Default State: OFF Default Dim Value: 100 % Current: 0 A
 Default Lock State: Unlocked Current Dim Value: 100 % Voltage: 0 V

Load Config From File... Save Config To File... Restore Factory Defaults
 Get Config From Device Put Config To Device Close

RED text indicates a changed parameter that has not yet been put to the device

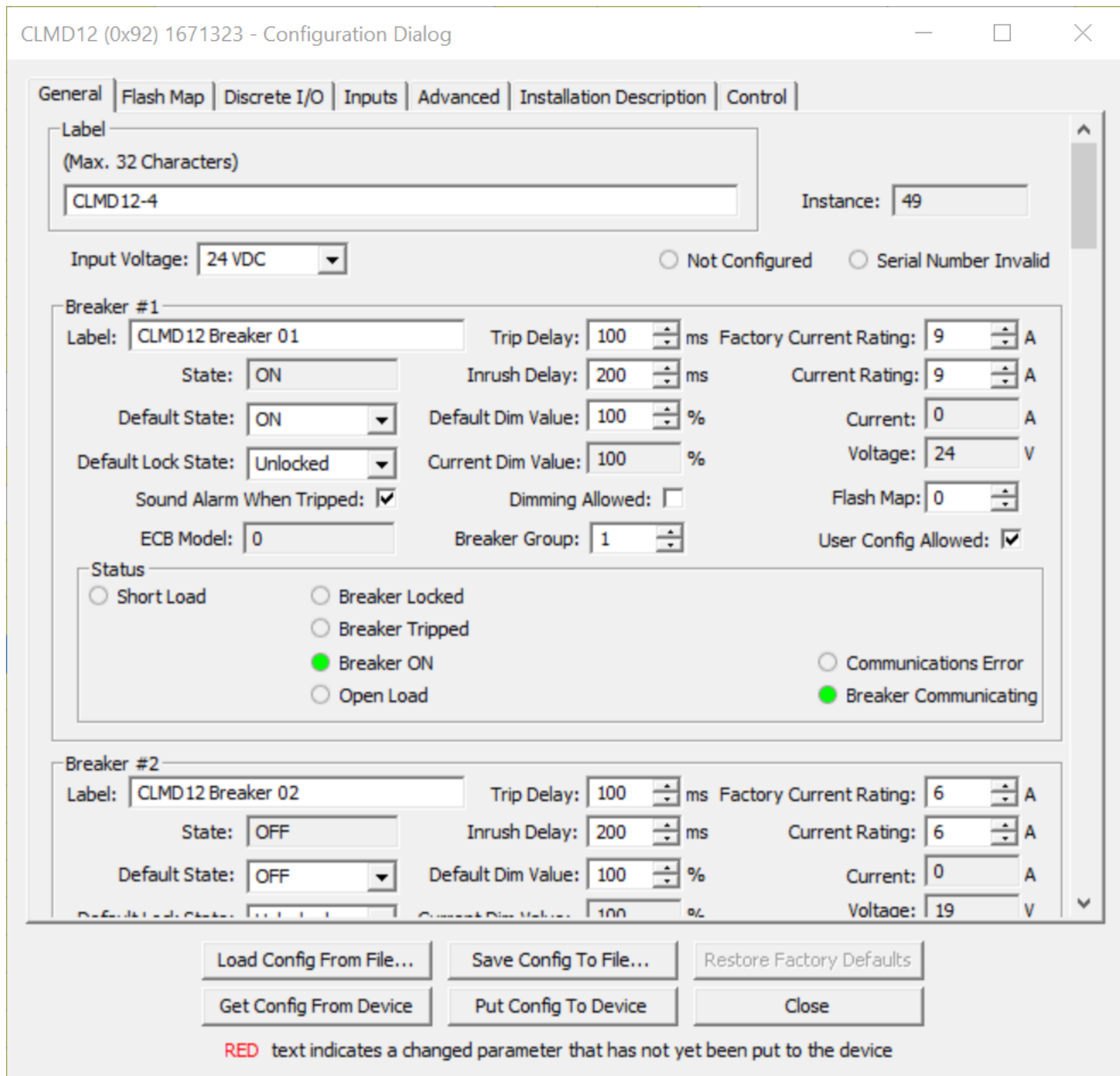

Figure 5 – CLMD12 General Tab

3.5.1.1 Label

This text box allows you to assign a text label to the device. This label is visible in Maretron analysis and display products and allows you to easily identify the particular device.

3.5.1.2 Instance

NMEA 2000® provides a unique instance number for each breaker box on a vessel. This read-only field shows the instance number assigned to this device. This instance number value is reflected in the 127501 Binary Status Report message. The instance number can be configured by changing the “Device Instance” field on the “Advanced” tab.

3.5.1.3 Input Voltage

This field allows you to configure nominal expected input voltage of the CLMD12. Choose from one of the following selections:

- 12 VDC
- 24 VDC
- 36 VDC
- Undefined

3.5.1.4 Not Configured

When lit, this read-only field indicates that the CLMD12 does not contain a valid configuration.

3.5.1.5 Serial Number Invalid

When lit, this read-only field indicates that the CLMD12 does not contain a valid serial number. Please contact Maretron technical support for assistance.

3.5.1.6 Breaker #*n*

This section contains settings for the specified circuit breaker. One of these sections is present for each of the breakers in the unit.

3.5.1.6.1 Label

This text box allows you to configure a text label for the breaker to identify it (for example, "RUNNING LIGHTS" or "HATCH"). For each breaker, set this to a value which describes the breaker so that you can easily identify it in display devices.

3.5.1.6.2 State

This read-only field indicates the current state of the breaker. It will contain one of the following values:

- OFF
- ON

3.5.1.6.3 Default State

This allows you to configure the state of the breaker when the CLMD12 is powered on. You can set this to one of the following values:

- OFF
- ON
- LAST KNOWN STATE

3.5.1.6.4 Default Lock State

This parameter allows you to configure whether the breaker is locked when the CLMD12 is powered on. You can set this to one of the following values:

- LOCKED
- UNLOCKED

3.5.1.6.5 Sound Alarm When Tripped

This parameter allows you to configure whether an alarm is sounded on OctoPlex Touch Screen displays whenever the breaker is tripped.

3.5.1.6.6 ECB Model

This read-only field shows the revision level of the ECB (electronic circuit breaker).

3.5.1.6.7 Trip Delay

This parameter allows you to configure the trip delay for the breaker (the current through the breaker must exceed the current rating of the breaker for this amount of time for the breaker to trip). This can be set in the range of 0 ms to 750 ms.

3.5.1.6.8 Inrush Delay

This parameter allows you to configure the inrush delay for the breaker. When the breaker is switched from OFF to ON, the current through the breaker can exceed the current rating of the breaker for this amount of time without the breaker tripping. This allows for a brief period of current inrush, preventing the circuit from inadvertently tripping when energized. This can be set in the range of 0 ms to 1500 ms.

3.5.1.6.9 Default Dim Value

This parameter allows you to configure the percent dimming value for the breaker when the CLMD12 is powered on. This value will be applied only if the Dimming Allowed box is checked. This can be set in the range of 5% to 100% with a resolution of 1%.

3.5.1.6.10 Current Dim Value

This read-only field shows the percent dimming value for the breaker.

3.5.1.6.11 Dimming Allowed

This parameter allows you to configure whether the channel is dimmable. Check this box to allow dimming commands to change the dimming level of the breaker and clear this box to force the breaker to operate at 100% dimming level.

3.5.1.6.12 Combine With

To parallel two breakers, select the number of the breaker you wish to combine this breaker with. The dropdown box will present a list of other breakers with the same current capability which may be paralleled with this breaker. If two breakers are paralleled, the breaker with the higher number mirrors the state of the breaker with the lower number. For example, if you parallel Breaker 1 and Breaker 2, any change in state of Breaker 1 will be mirrored by Breaker 2.

3.5.1.6.13 Factory Current Rating

This parameter allows you to configure the maximum value to which the Current Rating can be configured. This parameter should be configured to the current rating for the wire connected to this breaker. The value you can program into this field is limited by the current capacity of the channel being programmed.

3.5.1.6.14 Current Rating

This parameter allows you to configure the desired trip level for this breaker. Exceeding this current will initiate a trip. The value you program into this field will be limited by the value in the Factory Current Rating field.

3.5.1.6.15 Current

This read-only field shows the real-time current passing through the breaker.

3.5.1.6.16 Voltage

This read-only field shows the real-time voltage at the load terminal of the breaker.

3.5.1.6.17 Flash Map

This parameter allows you to configure a breaker to use a flash map. A value of 0 means that the breaker is not assigned to any flash map, and a value of 1 through 15 assigns the breaker to the flash map corresponding to that number.

3.5.1.6.18 User Config Allowed

This parameter allows you to configure whether configuration changes can be made to the breaker. If this is checked, other configuration parameters for the breaker can be changed. If this is cleared, other configuration parameters for the breaker cannot be changed.

3.5.1.6.19 Status

This group of indicators show real-time status of the breaker.

3.5.1.6.19.1 Short Load

When lit, this read-only field indicates that the breaker has tripped due to a detected short circuit.

3.5.1.6.19.2 Breaker Locked

When lit, this read-only field indicates that the breaker has been locked and will not respond to switch commands on the network. The purpose of the lock feature is to avoid inadvertent or accidental breaker state changes. The breaker must be unlocked before the breaker state can be remotely changed again.

3.5.1.6.19.3 Breaker Tripped

When lit, this read-only field indicates that the breaker has tripped due to an overcurrent condition. Switch the breaker OFF to acknowledge the 'breaker tripped' indication. You can then switch the breaker back to the ON position.

3.5.1.6.19.4 Breaker ON

When lit, this read-only field indicates that the breaker is in the ON state.

3.5.1.6.19.5 Open Load

When lit, this read-only field indicates an Open Load (no load) condition which indicates that the breaker is turned ON but there is little or no current being drawn. Possible conditions:

- External switch controlling load is in the OFF position
- If the connected load is a light, the bulb could be defective
- The load is miswired
- The load is very small (less than 1.0 Amp)

3.5.1.6.19.6 Communications Error

When lit, this read-only field indicates that the breaker has lost communication with the main processor.

3.5.1.6.19.7 Breaker Communicating

When lit, this read-only field indicates that the breaker is communicating with the network.

3.5.1.7 Flash Map

The Flash Function allows control of a breaker to be periodic. Common uses of this function include turning off a head fan or light after a set period of time, etc. Three parameters dictate the behavior of the circuit and are detailed below. A maximum of 15 flash table entries may be defined.

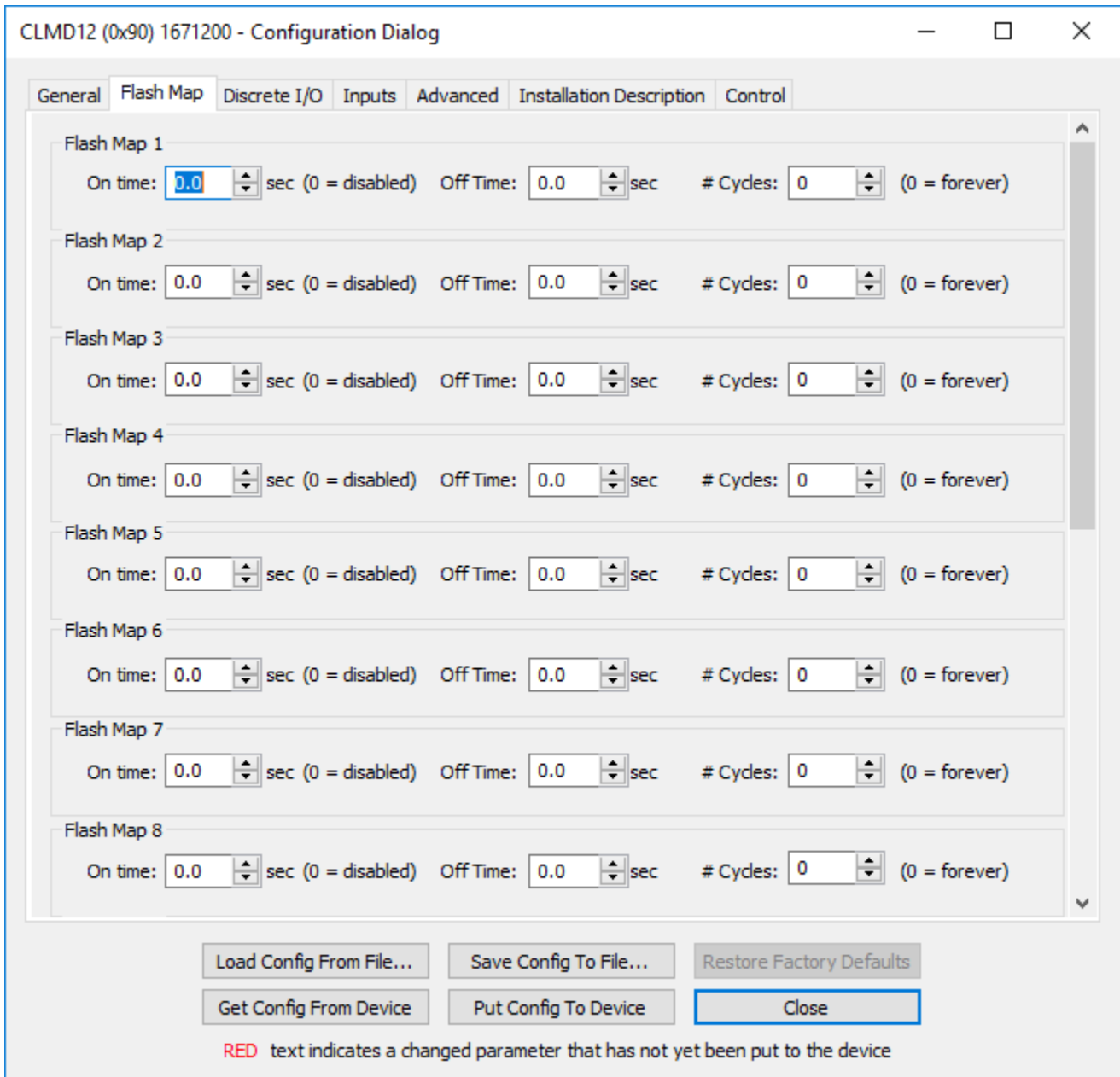

Figure 6 – CLMD12 Flash Map Tab

3.5.1.7.1 Cycles

This parameter allows you to configure the number of cycles that this flash map will execute after a breaker configured to use this flash map has been switched to the ON state. A value of 0 will repeat the cycle indefinitely, and values in the range of 1 cycle to 255 cycles will execute that number of cycles.

3.5.1.7.2 On Time

This parameter allows you to configure the time that a breaker will be ON during a cycle. This can be set to a value in the range of 0 seconds to 6553.5 seconds in increments of 0.1 seconds.

3.5.1.7.3 Off Time

This parameter allows you to configure the time that a breaker will be OFF during a cycle. This can be set to a value in the range of 0 seconds to 6553.5 seconds in increments of 0.1 seconds. A value of 0 will disable this flash map.

3.5.1.8 Discrete I/O

When a device transmitting the 127501 Binary Status Report message is part of the installation, it can be configured to control the behavior of the breakers. This includes the seven input channels present on the CLMD12. Up to thirty-six Discrete I/O's can be programmed. One Discrete I/O can control multiple breakers up to the box limit. The Discrete I/O state is maintained independent of any breaker state. Therefore, if a breaker is being controlled from multiple input signals (DIO's), an "out of state" situation is possible when input signals are switched. Example: two wall switches are controlling the same light (breaker), depending on the state of the signal a second touch of the switch may be required to obtain the desired action.

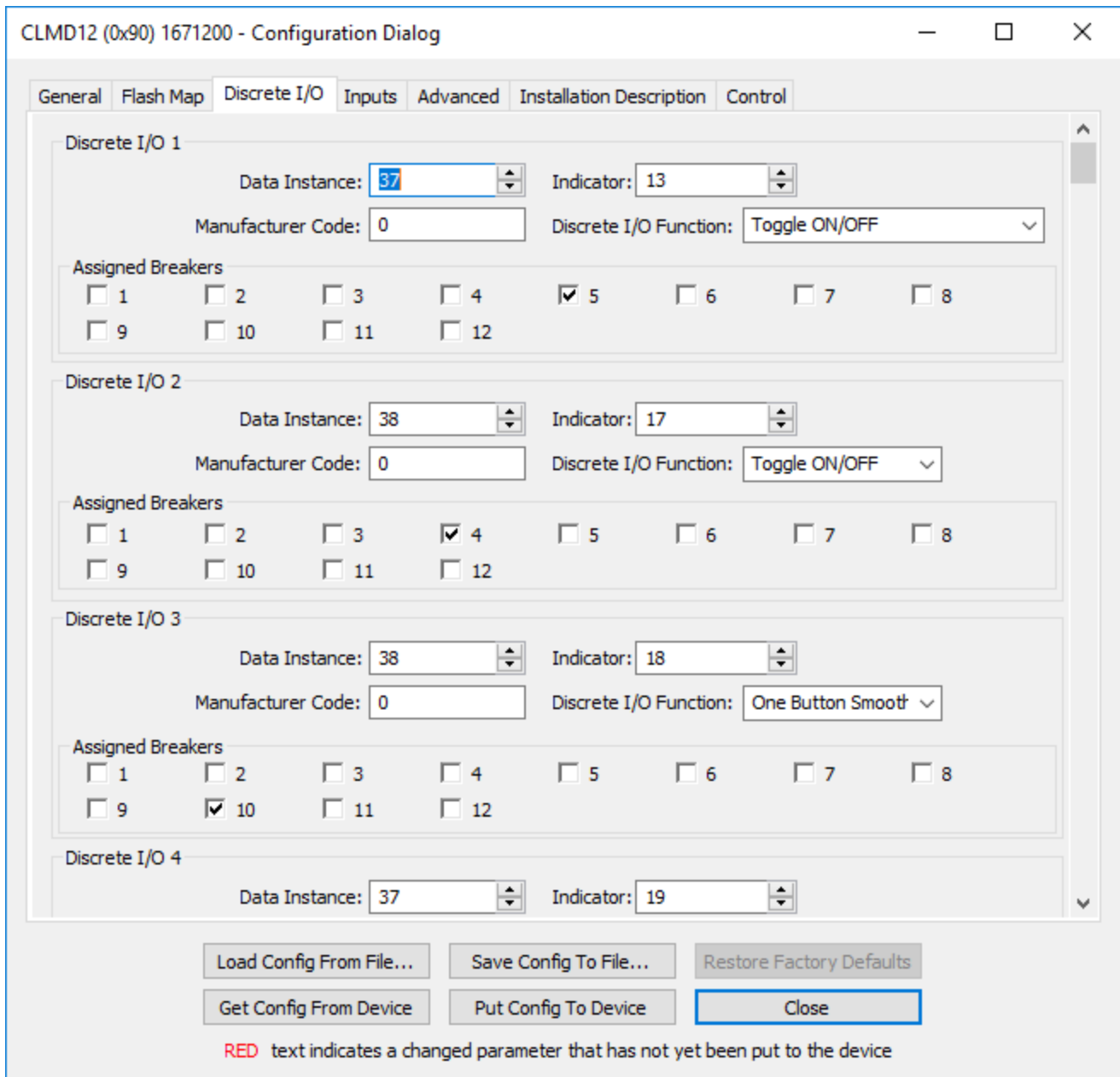

Figure 7 – CLMD12 Discrete I/O Tab

3.5.1.8.1 Data Instance

This parameter allows you to configure the data instance of the 127501 Binary Status Report message that will be used to control this discrete I/O circuit. To assign a discrete input from this device to this discrete I/O circuit, enter the instance value assign to this device (the value of the “Instance” field on the “General” tab).

3.5.1.8.2 Indicator

This parameter allows you to configure the indicator number within the 127501 Binary Status Report status message whose instance field matches the “Data Instance” parameter for this channel that will be used to control this discrete I/O circuit.

3.5.1.8.3 Manufacturer Code

This parameter allows you to configure the manufacturer code that must be reported by the device transmitting the 127501 Binary Status Report message that will be used to control this discrete I/O circuit. Setting this value to 2047 means that any manufacturer code will be accepted.

3.5.1.8.4 Discrete I/O Function

This parameter allows you to configure how the specified 127501 Binary Status Report indicator will control the assigned breaker. The following functions may be selected:

Discrete I/O Function	Description
Always Turn ON	Turns the breaker ON when the monitored signal becomes active
Always Turn OFF	Turns the breaker OFF when the monitored signal becomes active
Toggle ON/OFF	An inactive to active edge on the monitored signal toggles the breaker from OFF to ON or from ON to OFF
Brighten	An inactive to active edge on the monitored signal increases the dimming level by 1%
Dim	An inactive to active edge on the monitored signal decreases the dimming level by 1%
Flash	An inactive to active edge on the monitored signal turns the breaker ON and uses the assigned flash map
Turn OFF w/Lock	The breaker turns OFF and stays LOCKED as long as the monitored signal is active. The breaker stays OFF but becomes UNLOCKED when the monitored signal becomes inactive
Unlock	Unlocks breaker (state does not change)
One Button Smooth High-to-Low	Single press changes breaker state. Press and hold wall switch to turn ON; hold for High to Low voltage decrease (1% increments). Continuing to hold will reset to 100% intensity and repeat.
One Button Smooth Low-to-High	Single press changes breaker state. Press and hold wall switch to turn ON; hold for Low to High dimming level increase (1% increments). Continuing to hold will reset to 5% dimming level and repeat.
Smooth Scroll	A momentary touch turns breaker ON only; continuing to hold scrolls dimming level UP and DOWN (last known state is retained).
One Button Smooth Scroll	A momentary touch changes breaker state; continuing to hold scrolls dimming level UP and DOWN (last known state is retained).
Discrete Momentary	The breaker stays on as long as the monitored signal remains active. The breaker turns OFF when the input becomes inactive.

3.5.1.8.5 Assigned Breakers

This parameter allows you to configure the breakers that will be controlled by this discrete I/O channel. You may select any number of the breakers.

3.5.1.9 Inputs

The CLMD12 has seven digital inputs. These inputs can be configured on the Inputs tab. The states of these input channels are transmitted in a 127501 Binary Status Report message as indicators 13 (Input Channel #1) through 19 (Input Channel #7).

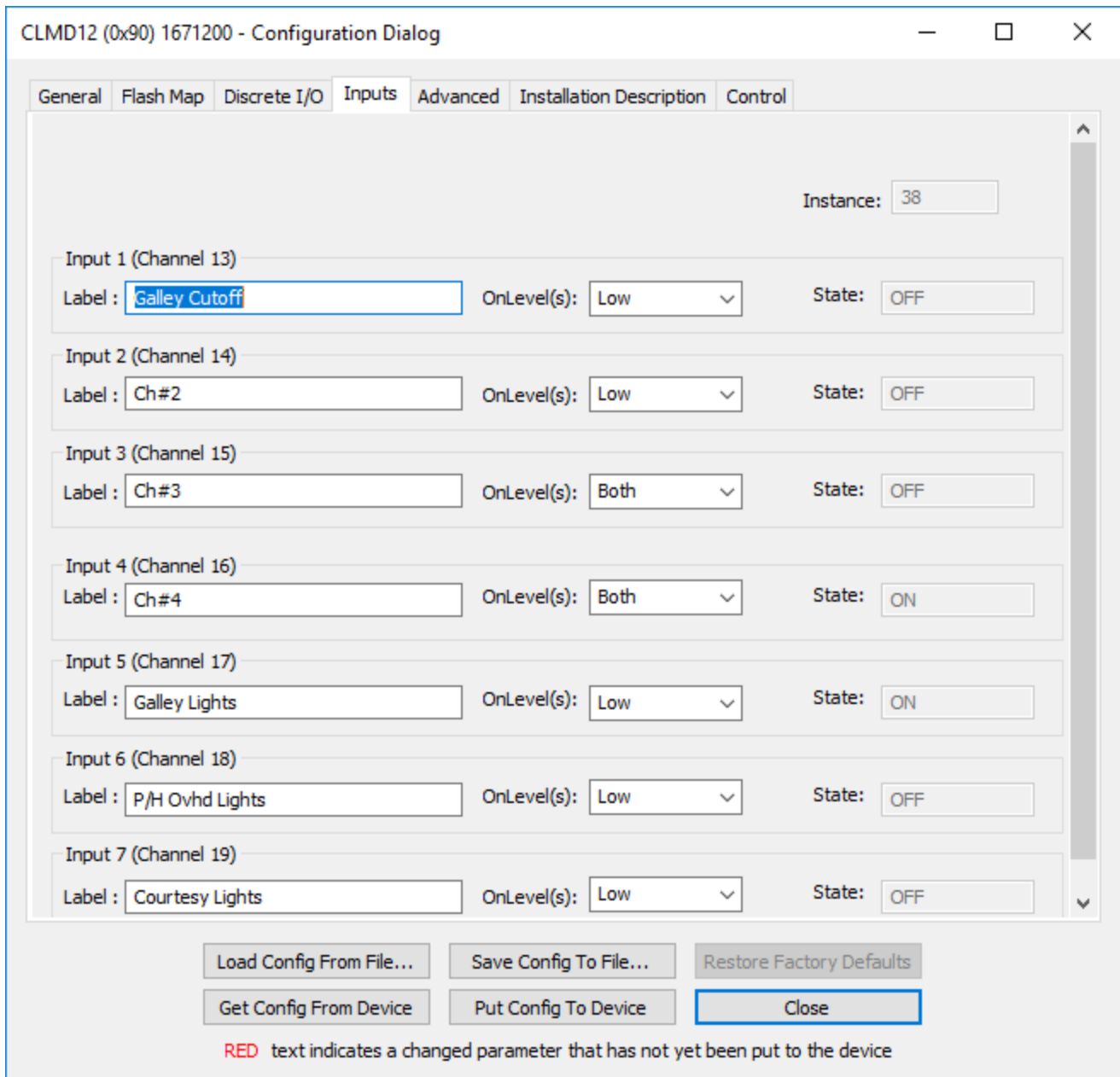

Figure 8 – CLMD12 Inputs Tab

3.5.1.9.1 Instance

This read-only field indicates the data instance used for this box. The value that appears here can be changed by setting the “Device Instance” parameter on the Advanced tab.

3.5.1.9.2 Channel

3.5.1.9.2.1 Label

Each channel has a text label you can set to identify the input signal monitored by that channel (for example, “BILGE PUMP” or “HATCH”). For each channel, set this to a value which describes the input being monitored so that you can easily identify it in display devices.

3.5.1.9.2.2 OnLevel(s)

This parameter allows you to configure the voltage level on the input signals that corresponds to an ON status on the input as reported on the network. You can use any of the following settings:

- High – a high voltage level on the input is represented as an ON value on the network. A high impedance or a low voltage level on the input is represented as an OFF value on the network.
- Low – a low voltage level on the input is represented as an ON value on the network. A high impedance or a high voltage level on the input is represented as an OFF value on the network.
- Both – a high voltage level or a low voltage level on the input is represented as an ON value on the network. A high impedance on the input is represented as an OFF value on the network.

3.5.1.9.2.3 State

This read-only field represents the current state of the input signal as reported on the network.

3.5.1.10 Advanced

The Advanced tab is used to configure and observe parameters that do not normally require changing.

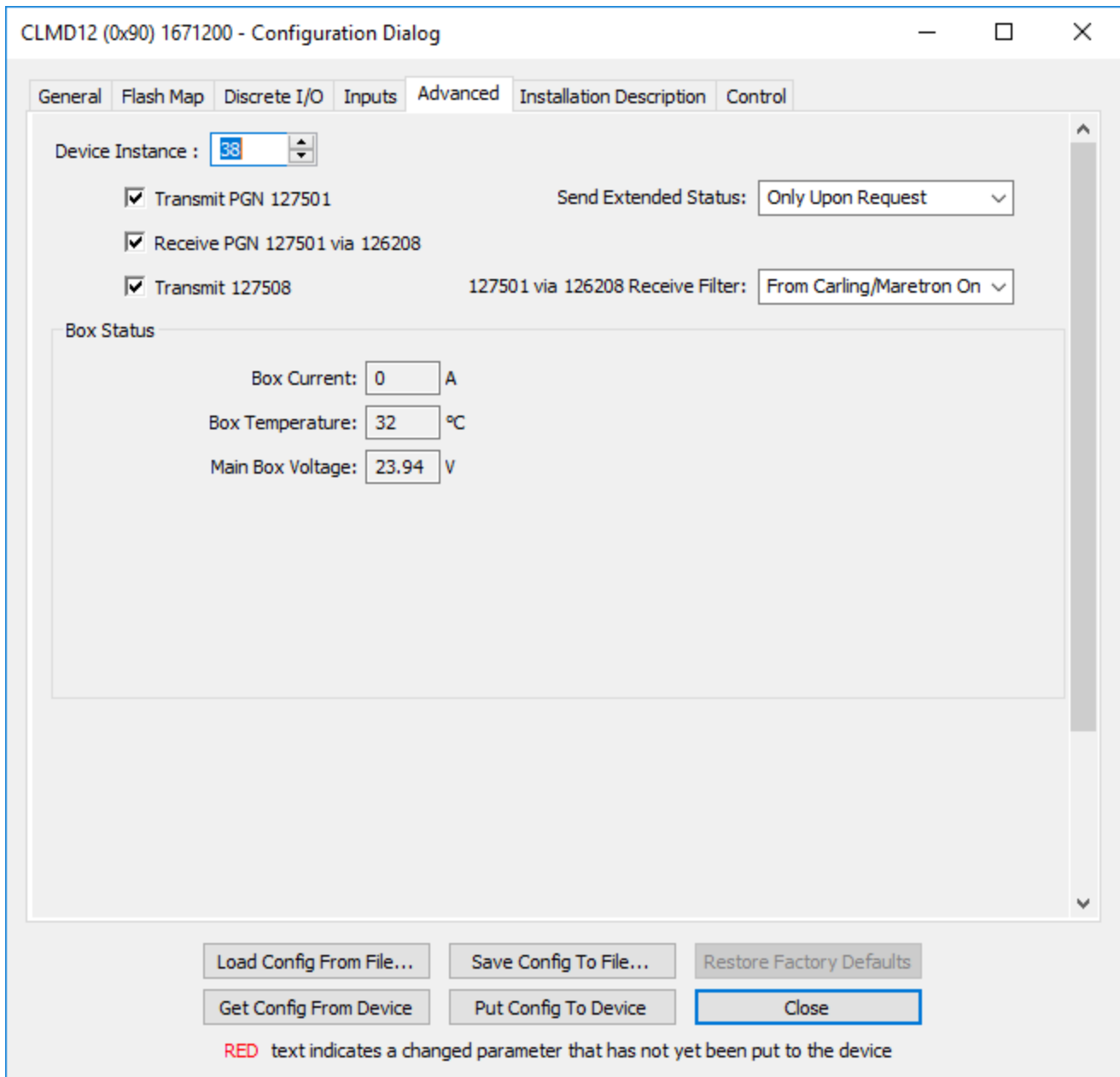

Figure 9 – CLMD12 Advanced Tab

3.5.1.10.1 Device Instance

This parameter allows you to configure the NMEA 2000 device instance used by the device. This value is also used as the data instance in the 127501 Binary Status Report messages transmitted by the device and can be seen on the General Tab as well as the Inputs Tab labeled as "Instance".

3.5.1.10.2 Transmit PGN 127501

This parameter allows you to configure whether the device transmits the 127501 Binary Status Report NMEA 2000 message. If this field is set, the device will transmit the 127501 Binary Status Report message along with proprietary messages. If this field is cleared, the device will not transmit the 127501 message and will transmit only proprietary messages.

3.5.1.10.3 Receive PGN 127501 via 126208

This parameter allows you to configure whether the device will respond to the NMEA command of an indicator in the 127501 Binary Status Report message. If this field is set, the device will respond to that message. If this field is cleared, the device will not respond to that message, but only to proprietary messages.

3.5.1.10.4 Transmit 127508

This parameter allows you to configure whether the device will transmit the 127508 Battery Status message to indicate the box temperature, input voltage, and input current. If this field is set, the device will transmit the 127508 message. If this field is cleared, the device will not transmit the 127508 message.

3.5.1.10.5 Send Extended Status

This parameter allows you to configure when the CLMD12 sends the extended box status proprietary message. There are two settings for this parameter:

- Only send when an error is detected
- Only send upon request

3.5.1.10.6 127501 via 126208 Receive Filter

This parameter allows you to configure from which devices the CLMD12 will accept 126208 NMEA Commands of the 127501 Binary Status Report message. There are two settings for this parameter:

- From Carling/Maretron devices only
- From any manufacturer's device

3.5.1.10.7 Box Status

3.5.1.10.7.1 Box Current

This read-only field indicates the total current passing through the device.

3.5.1.10.7.2 Box Temperature

This read-only field indicates the internal temperature of the device.

3.5.1.10.7.3 Main Box Voltage

This read-only field indicates the voltage of the power input for the device.

3.5.1.11 Installation Description

This tab allows you to set values for the installation description properties of the device.

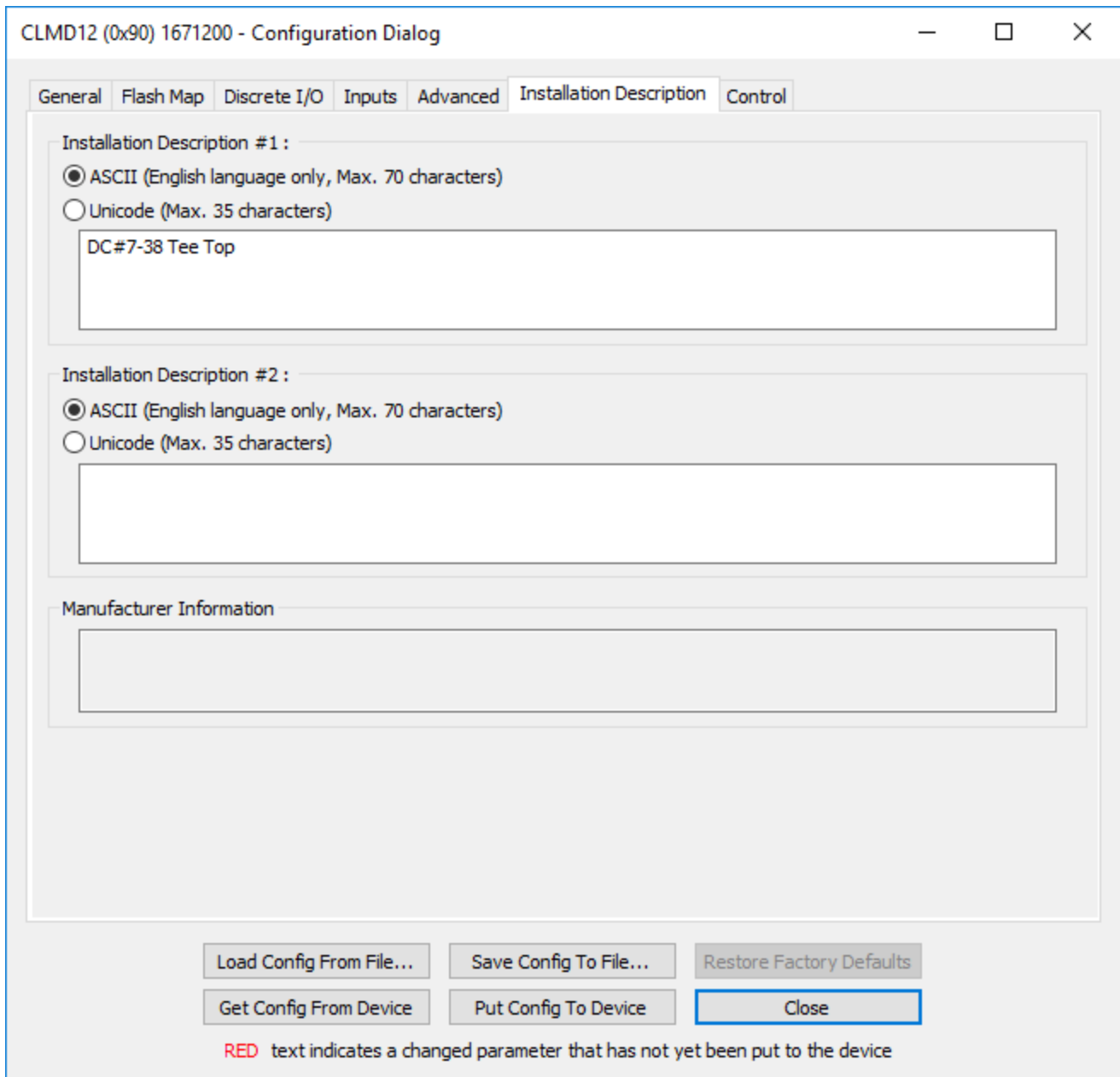

Figure 10 – CLMD12 Installation Description Tab

3.5.1.11.1 Installation Description #1, #2

This device, along with all other certified NMEA devices, has two user-programmable installation description fields. You may program these fields with information specific to the device, such as date installed, the initials/name of the installer, the physical location of the device, etc. This configuration option will allow you to program the values of these fields.

3.5.1.12 Control

This tab allows you to control the ON/OFF state and dimming level of the breakers on the device. This is normally used for testing purposes.

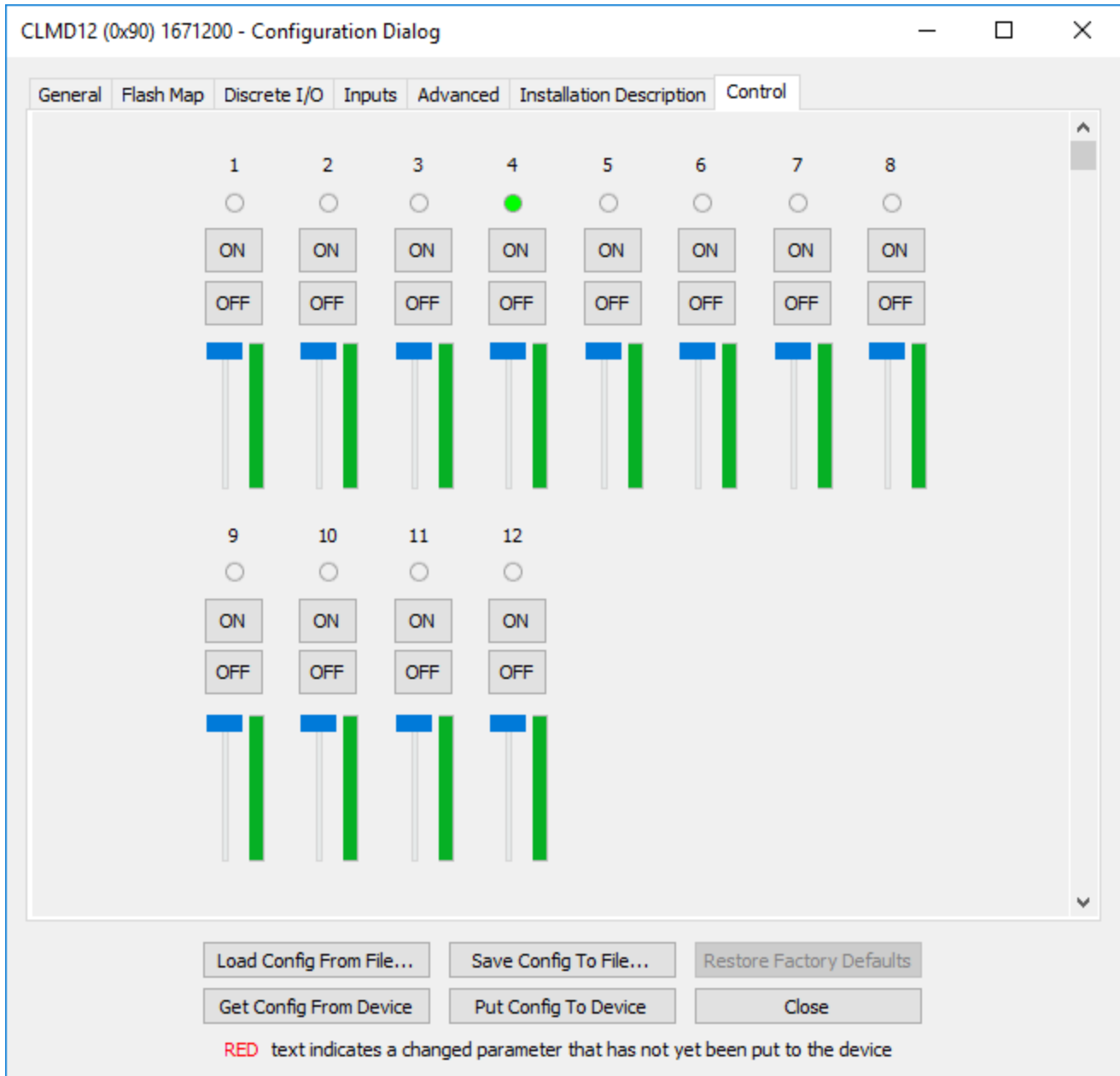

Figure 11 – CLMD12 Control Tab

3.5.1.12.1 Status LED

When lit, this read-only field indicates that the breaker is in the ON state. When dim, this field indicates that the breaker is in the OFF state.

3.5.1.12.2 ON/OFF Buttons

The ON button allows you to switch the breaker into the ON state. The OFF button allows you to switch the breaker into the OFF state.

3.5.1.12.3 Dimmer Slider

The blue slider bar allows you to configure the dimming level of a breaker between 5% and 100%. The read-only green bar graph shows the real-time dimming level of the breaker.

4 Operation

4.1 Manual Breaker Control

Breakers may be manually turned on and off via messages received over the NMEA 2000 network.

4.2 Automatic Breaker Control by Flash Function

The Flash Function allows control of a breaker to be periodic. Common uses of this function include controlling a foghorn, automatically turning off a head fan or light after a set period of time, etc. Three parameters dictate the behavior of the circuit and are set via the Maretron N2KAnalyzer utility. A maximum of 15 flash table entries may be defined.

- Flash ON time: Duration of time the load is ON
- Flash OFF time: Duration of time the load is OFF
- Number of Cycles: Number of times to repeat the cycle – 0 to 255 (0 will cause the cycle to be repeated indefinitely)

4.3 Automatic Breaker Control by Discrete I/O Function

When a device which transmits a 127501 Binary Status Report message is present on the NMEA 2000 network or internal discrete inputs are utilized, the indicator states transmitted in these messages can be configured to control the behavior of the breakers. 12 Discrete I/O's from SIU and/or 7 on-board discrete inputs per CLMD12 can be programmed. One Discrete I/O can control multiple breakers up to the box limit. The Discrete I/O state is maintained independent of any breaker state. Therefore, if a breaker is being controlled from multiple input signals (DIO's) an "out of state" situation is possible when input signals are switched. Example: two wall switches are controlling the same light (breaker) – depending on the state of the signal, a second touch of the switch may be required to obtain the desired action.

Discrete I/O Function	Description
Always Turn ON	Turns the breaker ON when the monitored signal becomes active
Always Turn OFF	Turns the breaker OFF when the monitored signal becomes active
Toggle ON/OFF	An inactive to active edge on the monitored signal toggles the breaker from OFF to ON or from ON to OFF
Brighten	An inactive to active edge on the monitored signal increases the dimming level by 1%
Dim	An inactive to active edge on the monitored signal decreases the dimming level by 1%
Flash	An inactive to active edge on the monitored signal turns the breaker ON and uses the assigned flash map
Turn OFF w/Lock	The breaker turns OFF and stays LOCKED as long as the monitored signal is active. The breaker stays OFF but becomes UNLOCKED when the monitored signal becomes inactive
Unlock	Unlocks breaker (state does not change)
One Button Smooth High-to-Low	Single press changes breaker state. Press and hold wall switch to turn ON; hold for High to Low voltage decrease (1% increments). Continuing to hold will reset to 100% intensity and repeat.
One Button Smooth Low-to-High	Single press changes breaker state. Press and hold wall switch to turn ON; hold for Low to High dimming level increase (1% increments). Continuing to hold will reset to 5% dimming level and repeat.

Discrete I/O Function	Description
Smooth Scroll	A momentary touch turns breaker ON only; continuing to hold scrolls dimming level UP and DOWN (last known state is retained).
One Button Smooth Scroll	A momentary touch changes breaker state; continuing to hold scrolls dimming level UP and DOWN (last known state is retained).
Discrete Momentary	The breaker stays on as long as the monitored signal remains active. The breaker turns OFF when the input becomes inactive.

4.4 Manual Bypass

The Maretron Mechanical Bypass Module (CBMD12) P/N A3675 can be installed in conjunction with the CLMD12.

The bypass module provides a manual method (On/Off switch) to control loads by providing power to each load in case of CLMD12 malfunction and/or NMEA 2000 network failure. The power outputs provided by the bypass module are over current protected via an individual fuse for each output. Please ensure that the current rating of the fuse for each load is appropriate to protect the load and the wiring for that load.

Please note that the bypass module does not support paralleled outputs, since each circuit is controlled by a separate switch. Additionally, the bypass module does not support dimming of circuits.



WARNING

The CBMD12 Mechanical Bypass Module is not ignition protected. Ensure that the area is free of fumes and gasses when the switches are cycled and when fuses are removed and/or installed.

To change control from the CLMD12 load controller module to the CBMD12 bypass module, please perform the following steps:

- 1) Ensure that the area is free of fumes and gasses.
- 2) Ensure that all switches on the CBMD12 bypass module are in the OFF position.
- 3) Connect power to the ¼"-20 power stud on the CBMD12 bypass module.
- 4) Unplug the J1 connector from the CLMD12 load controller module.
- 5) Plug the J1 connector into the CBMD12 bypass module.
- 6) For the circuits you wish to energize, set the corresponding switches on the CBMD12 bypass module to the ON position.

Please refer to the diagram of how the bypass module is installed below in Figure 12.

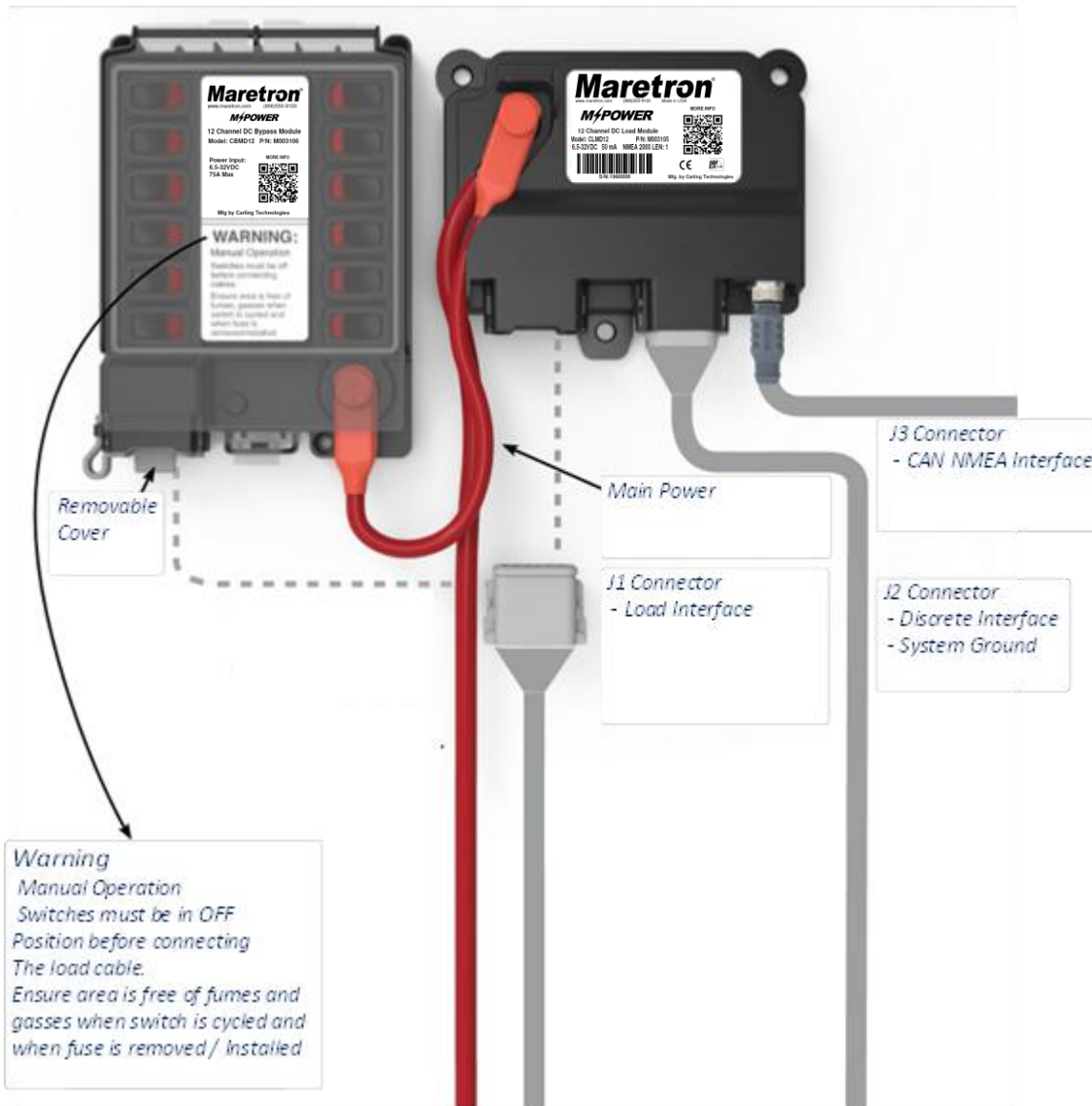

Figure 12 – Bypass Module Usage

5 Maintenance



WARNING

The CLMD12 DC 12 Channel Load Controller Module is operated under remote control. Before servicing any load device connected to the CLMD12, you must first disconnect the wire between the CLMD12 load terminal and the load device. Failure to do so can result in serious bodily harm.

Regular maintenance is important to ensure continued proper operation of the Maretron CLMD12. Perform the following tasks periodically:

- Clean the unit with a soft cloth. Do not use chemical cleaners as they may remove paint or markings or may corrode the CLMD12 enclosure or seals. Do not use any cleaners containing acetone, as they will deteriorate the plastic enclosure.
- Ensure that the unit is mounted securely and cannot be moved relative to the mounting surface. If the unit is loose, tighten the mounting screws.
- Check the security of the cable connected to the NMEA 2000® connector and tighten if necessary.
- Check the security of all of the input and output connections to the unit and tighten if necessary.

6 Troubleshooting

If you notice unexpected operation of the Maretron CLMD12, follow the troubleshooting procedures in this section to remedy simple problems. If these steps do not solve your problem, please contact Maretron Technical Support (refer to Section 8 for contact information).

Symptom	Troubleshooting Procedure
No breaker/switch data visible on NMEA 2000® network.	<ul style="list-style-type: none"> • Ensure that the CLMD12 is properly connected to the NMEA 2000® network. • Ensure that the CLMD12 instance of the breaker/switch component matches the instance programmed into the CLMD12, as described in Section 3.5.1.10.1.
A breaker/switch always reads "Error"	<p>The CLMD12 may have shut down the affected channel due to an overtemperature or overcurrent condition detected on the CLMD12 breaker itself.</p> <ul style="list-style-type: none"> • Ensure that the current drawn by the load is less than the current rating for the connected channel. • Ensure that no short circuits or other wiring problems exist on the load circuit, and reset the channel by turning it OFF, then ON. • If the breaker or switch control returns to the error state, closely examine the load wiring for problems and ensure that the load draws the appropriate amount of current.
A breaker/switch is "ON", but the load is not powered.	<ul style="list-style-type: none"> • Ensure that the load is connected to the load terminal of the same CLMD12 channel that the breaker/switch component is controlling. • Ensure that the load's terminal which is not connected to the CLMD12 is connected to vessel ground. • Ensure that the connection between the breaker and the channel's power terminal is good. • Ensure that the breaker supplying power to the channel is not tripped.

<p>You can see, but not control, the state of a breaker/switch</p>	<ul style="list-style-type: none">• If you are controlling the load via a DSM-Series display, ensure that it is running at least firmware revision 1.4.10.• If you are controlling the load via N2KView software, ensure that you have a switch control license for the software.
--	--

7 Technical Specifications

As Carling is constantly improving its products, all specifications are subject to change without notice. Maretron products are designed to be accurate and reliable; however, they should be used only as aids to navigation and not as a replacement for traditional navigation aids and techniques.

Specifications

Parameter	Value
Number of Output Channels	12
Switching Voltage	<32VDC
Maximum Unit Current Capacity	75 Amps
Channel Maximum Current Ratings	4x5A, 6x10A, 2x12A

Certifications

Parameter	Comment
NMEA 2000® Standard	Certified
CE Mark	Recreational Craft Directive 2014/35/EU

NMEA 2000® Parameter Group Numbers (PGNs)

Description	PGN #	PGN Name	Default Rate
Periodic Data PGNs	65300	Carling Proprietary	1 time / 4 seconds
	127500	Load Controller Connection State & Control	1 time / 4 seconds and on switch change
	127501	Binary Status Report	1 time / 15 seconds and on switch change
	127751	DC Voltage / Current	1 time / 1.5 seconds and on switch change
Response to Requested PGNs	126464	PGN List (Transmit and Receive)	N/A
	126996	Product Information	N/A
	126998	Configuration Information	N/A
	130818	Maretron Proprietary	N/A
	130825	Maretron Proprietary	N/A
	130921	Carling Proprietary	N/A
Protocol PGNs	059392	ISO Acknowledge	N/A
	059904	ISO Request	N/A
	060928	ISO Address Claim	N/A
	126208	NMEA Request/Command/Acknowledge	N/A
	126993	Heartbeat	1 time / 60 seconds

CLMD12 User's Manual

Electrical

Parameter	Value	Comment
Voltage Input Range	6.5 to 32 VDC	DC Voltage
Power Consumption	150 mA @ 12 VDC 70 mA @ 24 VDC	NMEA 2000® Interface
Load Equivalence Number (LEN)	3	NMEA 2000® Spec. (1LEN = 50 mA)
Reverse Battery Protection	Yes	Indefinitely
Load Dump Protection	Yes	Energy Rated per SAE J1113
Channel Current Measurement Accuracy	+/- 0.5 Amps	Typical
Channel Current Measurement Resolution	0.1 Amps	
Minimum Channel Current Measurement	0.5 Amps	
PWM (all breakers)		
Frequency	200 Hz	
Maximum Peak Current	3.0 Amps	
Load	Inductive load interface not recommended	
Duty Cycle Range	5% - 100%	
Duty Cycle Resolution	1%	
Programmable Trip Level Resolution	1 Amp	
Discrete Input Channels		
Absolute Voltage Limits	-2.3 – 36 VDC	
Input Resistance	1KΩ	
Input Voltage, Open Circuit	2.75 V	
Low Voltage Threshold	0 to 1.02 V	
Open Voltage Threshold	1.51 – 4.31 V	
High Voltage Threshold	4.82 – 32.0 V	

Mechanical

Parameter	Value	Comment
Size	5.7" x 5" x 1.6" (144.8mm x 127mm x 40.6mm)	Including Flanges for Mounting
Weight	1.32 lb. (0.599 kg)	
Power Stud Torque Value	20 in-lbs. (2.26 N·m)	

Environmental

Parameter	Value
IEC 60945 Classification	Exposed
Degree of Protection	IP67
Operating Temperature	-40°C to 85°C
Storage Temperature	-40°C to 85°C
Electric Field	100V/m
Ignition Protection	Ignition Protected

Environmental Testing

Parameter	Standard	Conditions
High Temperature Soak	EN 60068-2-2:2007	Duration 96hrs, T _{max} = 85°C
Low Temperature Soak	EN 60068-2-1:2007	96 hrs, T _{min} = -40°C
Temperature Cycling (Operating)	IEC 60068-2-14:2009	T _{min} = -40°C, T _{max} = 85°C
Temperature Shock (Storage)	IEC 60068-2-14:2009	T _{min} = -40°C, T _{max} = 85°C

Parameter	Standard	Conditions
Simulated Solar Radiation	EN 60068-2-5:2010	Procedure = B, 10 days @ 40°C
Altitude (Transport)	EN 60068-2-13:1999	ALT _{min} = Sea Level, ALT _{max} = 13600m
Altitude (Operational)	EN 60068-2-13:1999	ALT _{min} = Sea Level, ALT _{max} = 4850m
Humidity (Soak)	EN 60068-2-78:2002	RH = 93% +/-3%, Exposure 10 days
Humidity - Cyclic	EN 60068-2-30:2005	RH (> 90%), 6 cycles of 24hrs
Dust Ingress	IEC 60529:2001	Method EN60529 Section 13 Result IP6X
Water Ingress	DIN 40050-9:1993 IEC 60529:2001	Method as DIN 40050-9 Result IP67
Mechanical Shock - Drop Test	EN 60068-2-32:1993	1000mm free-fall, all faces of 3 axes
Mechanical - Shock	60068-2-27:2009	500m/s ² , pulse duration 11ms
Mechanical - Bump	60068-2-29:1993	400m/s ² 6ms shock pulses, 3 axes
Vibration (General)	60068-2-6: 1996	Sine shaped sweep 5 Hz to 500 Hz
Vibration (Random)	EN 60068-2-64:1995	Method 1
Vibration (Resonant Search)	60068-2-6: 1996	frequency range 10 Hz – 2 kHz @ 5G
Chemical Resistance	EN 60068-2-74:2000	Test method = B
Salt Spray	EN 60068-2-52: 1996	Chamber Temperature = 35°C
Ozone	ASTM D1171-99	Method A rating 0
Electrical (Operating Voltage)	SAE J1455:2011 Sect 4.13.1	Test for impaired function
Electrical (Over Voltage)	SAE J1455:2011 Sect 4.13.1	Test for impaired function +24V, +36V
Electrical (Reverse Polarity)	SAE J1455:2011 Sect 4.13.1	Test for impaired function -24V, -36V
Electrical (Short Circuit)	SAE J1455:2011 Sect 4.13.1	Operate at: +16V, +32V
Electrical (Power Up)	SAE J1455:2011 Sect 4.13.1	Ramp: 0 to 9 VDC, 0 to 18 VDC
Component Test - Electrical Transients Immunity	ISO 11451-1:2005 ISO 11452-2:2004	Refer to STD00140_2 - Table 17. 100 V/m
Component Test - Electrical Transients Emissions	ISO 13766:2006 Section 5 Annex D and Annex E	Distance of 1 m in the horizontal and vertical polarization, 30 MHz to 1 GHz
Component Test - Electrical Transients Conducted Transients	ISO 13766:2006 ISO 7637-2:2011	Method as per ISO 7637-2-Annex A
Electrostatic Discharge (ESD)	ISO 13766:2006	+/- 8 kV (Direct), +/- 15 kV (Air)
Ignition Protection Test	SO 8846:201, SAE J1171:2016	USCG recommended procedures

8 Mechanical Drawing

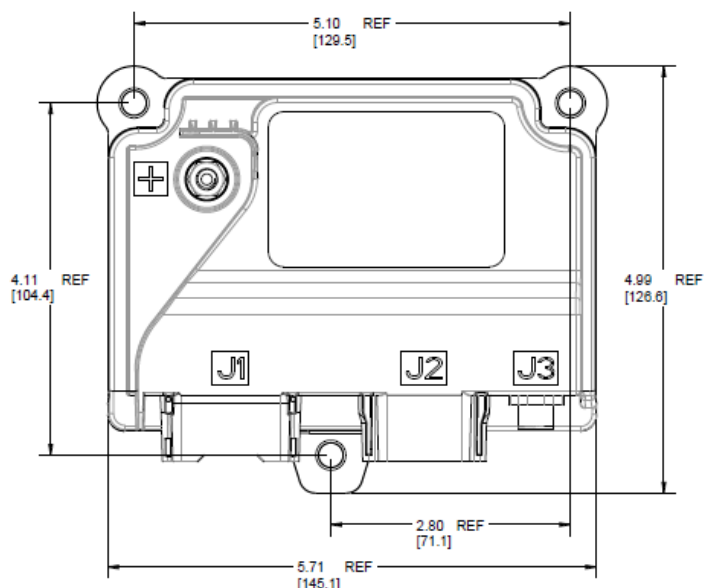

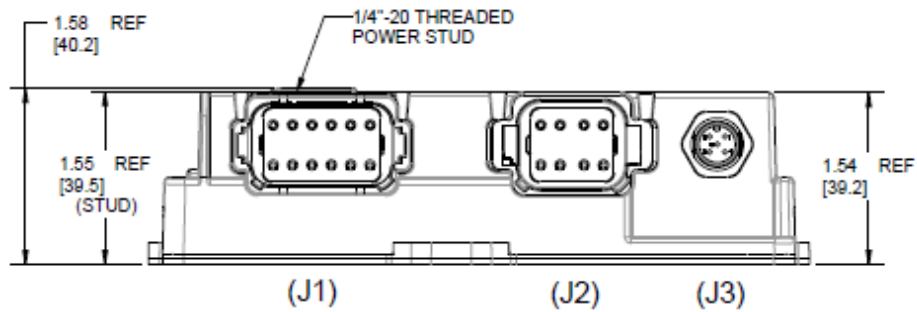

9 Technical Support

If you require technical support for Maretron products, you can reach us in any of the following ways:

Telephone: 1-866-550-9100
Fax: 1-602-861-1777
E-mail: support@maretron.com
World Wide Web: <http://www.maretron.com>
Mail: Carling Technologies, Inc.
Attn: Maretron Technical Support
120 Intracoastal Pointe Dr.
Jupiter, FL 33477 USA

10 Installation Template

Please check the dimensions before using the following diagram as a template for drilling the mounting holes because the printing process may have distorted the dimensions.

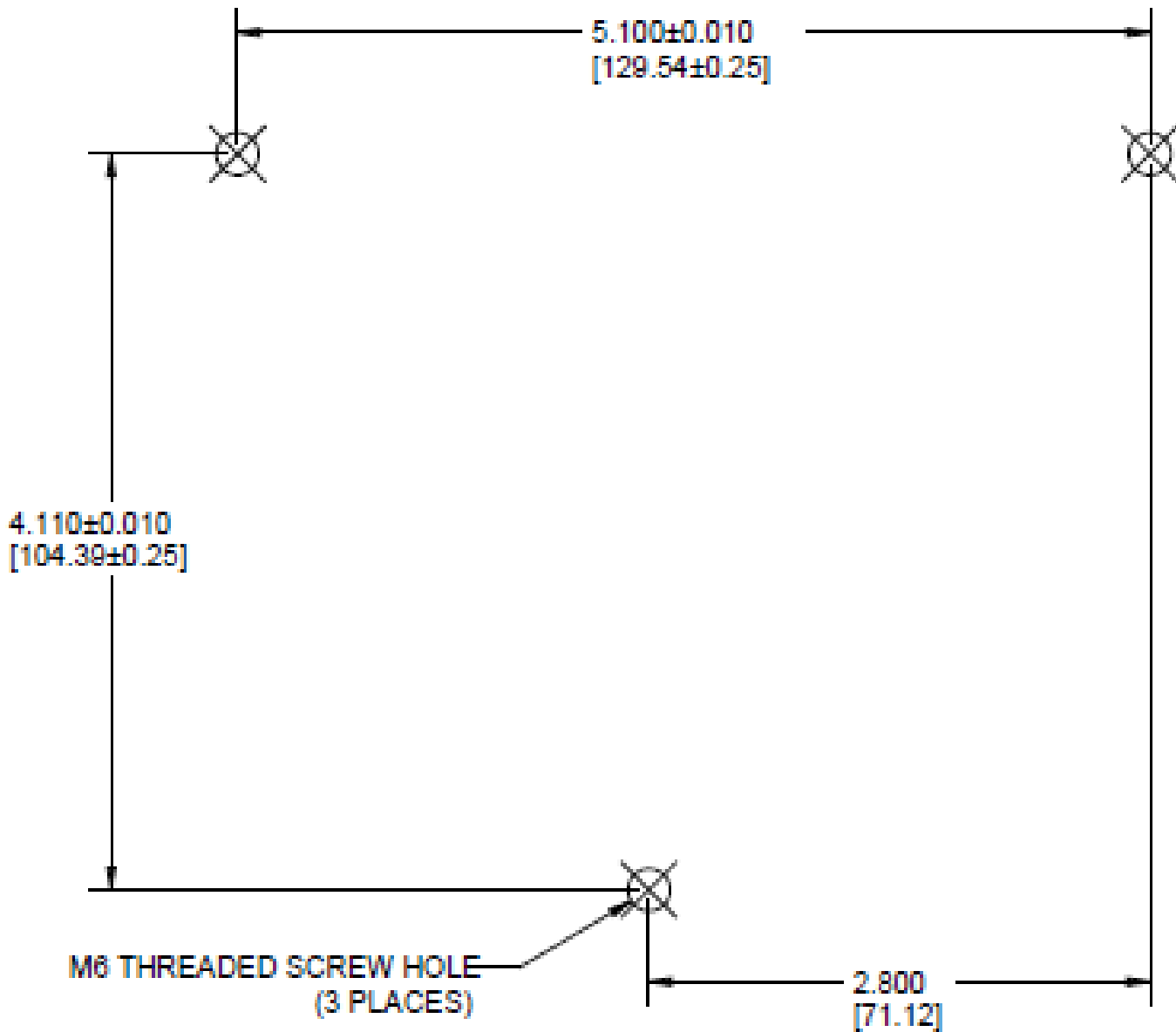

MOUNTING HOLE PATTERN SCALE 1.000

Figure 13 – Mounting Surface Template

11 Maretron (2 Year) Limited Warranty

Carling Technologies warrants the Maretron® CLMD12 to be free from defects in materials and workmanship for **two (2) years** from the date of original purchase. If within the applicable period any such products shall be proved to Carling's satisfaction to fail to meet the above limited warranty, such products shall be repaired or replaced at Carling's option. Purchaser's exclusive remedy and Carling's sole obligation hereunder, provided product is returned pursuant to the return requirements below, shall be limited to the repair or replacement, at Carling's option, of any product not meeting the above limited warranty and which is returned to Carling; or if Carling is unable to deliver a replacement that is free from defects in materials or workmanship, Purchaser's payment for such product will be refunded. Carling assumes no liability whatsoever for expenses of removing any defective product or part or for installing the repaired product or part or a replacement therefore or for any loss or damage to equipment in connection with which Maretron® products or parts shall be used. With respect to products not manufactured by Carling, Carling's warranty obligation shall in all respects conform to and be limited to the warranty actually extended to Carling by its supplier. The foregoing warranties shall not apply with respect to products subjected to negligence, misuse, misapplication, accident, damages by circumstances beyond Carling's control, to improper installation, operation, maintenance, or storage, or to other than normal use or service.

THE FOREGOING WARRANTIES ARE EXPRESSLY IN LIEU OF AND EXCLUDES ALL OTHER EXPRESS OR IMPLIED WARRANTIES, INCLUDING BUT NOT LIMITED TO THE IMPLIED WARRANTIES OF MERCHANTABILITY AND OF FITNESS FOR A PARTICULAR PURPOSE.

Statements made by any person, including representatives of Carling, which are inconsistent or in conflict with the terms of this Limited Warranty, shall not be binding upon Carling unless reduced to writing and approved by an officer of Carling.

IN NO CASE WILL CARLING BE LIABLE FOR INCIDENTAL OR CONSEQUENTIAL DAMAGES, DAMAGES FOR LOSS OF USE, LOSS OF ANTICIPATED PROFITS OR SAVINGS, OR ANY OTHER LOSS INCURRED BECAUSE OF INTERRUPTION OF SERVICE. IN NO EVENT SHALL CARLING'S AGGREGATE LIABILITY EXCEED THE PURCHASE PRICE OF THE PRODUCT(S) INVOLVED. CARLING SHALL NOT BE SUBJECT TO ANY OTHER OBLIGATIONS OR LIABILITIES, WHETHER ARISING OUT OF BREACH OF CONTRACT OR WARRANTY, TORT (INCLUDING NEGLIGENCE), OR OTHER THEORIES OF LAW WITH RESPECT TO PRODUCTS SOLD OR SERVICES RENDERED BY CARLING, OR ANY UNDERTAKINGS, ACTS OR OMISSIONS RELATING THERETO.

Carling does not warrant that the functions contained in any software programs or products will meet purchaser's requirements or that the operation of the software programs or products will be uninterrupted or error free. Purchaser assumes responsibility for the selection of the software programs or products to achieve the intended results, and for the installation, use and results obtained from said programs or products. No specifications, samples, descriptions, or illustrations provided Carling to Purchaser, whether directly, in trade literature, brochures or other documentation shall be construed as warranties of any kind, and any failure to conform with such specifications, samples, descriptions, or illustrations shall not constitute any breach of Carling's limited warranty.

Warranty Return Procedure:

To apply for warranty claims, contact Carling Technologies or one of its Maretron dealers to describe the problem and determine the appropriate course of action. If a return is necessary, place the product in its original packaging together with proof of purchase and complete a Return Merchandise Authorization (RMA) on the following web page:

https://www.maretron.com/rma_request.php

You will be contacted by email with instructions on where to send the unit for repair / evaluation. You are responsible for all shipping and insurance charges. Carling will return the replaced or repaired product with all shipping and handling prepaid except for requests requiring expedited shipping (i.e. overnight shipments). Failure to follow this warranty return procedure could result in the product's warranty becoming null and void.

Carling reserves the right to modify or replace, at its sole discretion, without prior notification, the warranty listed above. To obtain a copy of the then current warranty policy for Maretron® products, please go to the following web page:

<http://www.maretron.com/company/warranty.php>

Appendix A – NMEA 2000® Interfacing

This appendix is intended to relate specific characteristics of the CLMD12 to how they are communicated via NMEA 2000® messages in order to help ascertain whether the messaging implemented by the CLMD12 is compatible with other NMEA 2000® products. It is not a complete description of the messages. If you require detailed information on the messages, please obtain a copy of the NMEA 2000® standard documents from the National Marine Electronics Association (www.nmea.org).

CLMD12 NMEA 2000® Periodic Data Transmitted PGNs

PGN 127500 – Load Controller Connection State/Control

The CLMD12 uses this PGN to transmit the state of each of the breakers. A separate occurrence of this message will be transmitted for each breaker. The state of each breaker may be controlled by issuing a 126208 NMEA Command for this message addressed to this device.

- Field 1: Sequence ID – This field is transmitted with a value of 255.
- 2: Connection ID – This field identifies the output channel (breaker) whose status is being reported in this message. The value of this field will be in the range of 0 (Breaker #1) through 11 (Breaker #12).
 - 3: State – This field indicates the state of the solid-state breaker.
 - 4: Status – This field indicates the status of the solid-state breaker.
 - 5: Operational Status & Control – This field is used to lock and unlock the solid-state breaker.
 - 6: PWM Duty Cycle – This field is used to control and report the PWM duty cycle of the solid-state breaker.
 - 7: TimeON – This field is used to report the ON time if the solid-state breaker is running under the control of a Flash Map.
 - 8: TimeOFF – This field is used to report the OFF time if the solid-state breaker is running under the control of a Flash Map.

PGN 127501 – Binary Status Report

The CLMD12 uses this PGN to transmit the state of each of the breakers and connected switch inputs. The state of the breakers may be controlled by issuing a 126208 NMEA Command for this message addressed to this device.

- Field 1: Indicator Bank Instance – This field identifies the particular switch bank to which this PGN applies. Please refer to Section 3.5.1.2 for instructions on how to program the value of this field.
- 2: Indicator #1 – This field indicates the state of the solid-state breaker on output channel #1. The state will be one of the following values:
 - “OFF” – The breaker is open – no current is supplied to the load.
 - “ON” – The breaker is closed – current is supplied to the load.
 - “Error” – The breaker is open due to an error condition

- 3: Indicator #2 – This field indicates the state of the solid-state breaker on output channel #2.
- 4: Indicator #3 – This field indicates the state of the solid-state breaker on output channel #3.
- 5: Indicator #4 – This field indicates the state of the solid-state breaker on output channel #4.
- 6: Indicator #5 – This field indicates the state of the solid-state breaker on output channel #5.
- 7: Indicator #6 – This field indicates the state of the solid-state breaker on output channel #6.
- 8: Indicator #7 – This field indicates the state of the solid-state breaker on output channel #7.
- 9: Indicator #8 – This field indicates the state of the solid-state breaker on output channel #8.
- 10: Indicator #9 – This field indicates the state of the solid-state breaker on output channel #9.
- 11: Indicator #10 – This field indicates the state of the solid-state breaker on output channel #10.
- 12: Indicator #11 – This field indicates the state of the solid-state breaker on output channel #11.
- 13: Indicator #12 – This field indicates the state of the solid-state breaker on output channel #12.
- 14: Indicator #13 – This field indicates the state sensed by the digital input on input channel #1. The state will be one of the following values:
 - “OFF” – The digital input voltage level is outside the range(s) programmed for “ON” levels
 - “ON” – The digital input voltage level is inside the range(s) programmed for “ON” levelsPlease refer to section 3.5.1.9.2.2 for details
- 15: Indicator #14 – This field indicates the state sensed by the digital input on input channel #2.
- 16: Indicator #15 – This field indicates the state sensed by the digital input on input channel #3.
- 17: Indicator #16 – This field indicates the state sensed by the digital input on input channel #4.
- 18: Indicator #17 – This field indicates the state sensed by the digital input on input channel #5.
- 19: Indicator #18 – This field indicates the state sensed by the digital input on input channel #6.
- 20: Indicator #19 – This field indicates the state sensed by the digital input on input channel #7.