



Nevata Instruction Manual NBPS200-1R/-2R

Thank You!

Thank you for choosing Nautic Alert® Nevata. Proudly engineered and assembled in the USA. We are confident your new purchase will provide an outstanding experience and years of durable, next-generation bilge technology without the float switch. Please take a few minutes to read through the instruction manual and familiarize yourself with the installation and setup process.

In the unlikely event your Nevata encounters technical issues, please consult the warranty section of this manual.

Please register your product at <https://www.nauticalalert.com/support/register-product/>

and see additional product info at www.nauticalalert.com

To ensure you have the latest instruction manual, please visit <https://www.nauticalalert.com/support/instruction-manuals/>

Technical Specifications

Operating Voltage: 12 and 24V DC systems. Absolute min/max 10V-37V

Operating Current:

Does not include bilge pump or external siren: 20mA (12V), 24mW

With Bilge Pump: See bilge pump electrical specifications

Sensor Range/Granularity/Accuracy: (From bottom of sensor) 1 to 32 inches, .1inch, +/- .1inch

Bilge Pump Max Current/Power: 16A/300W

Operating Temperature: -20 to 55C

Transducer Frequency: 44KHz to 46KHz

Certifications:

UL 508
Compliant



Enclosure: Watertight and submersible

Patents: US8531316 B2, USD687733 S1, US20140266793 A1

Copyright ©2009 – 2017, Market Spectrum, Inc., USA. All rights reserved

Nevata Background

Nevata is the most advanced, comprehensive bilge controller ever created for early detection of critical bilge events. By sitting above the waterline, Nevata revolutionizes bilge technology by eliminating the root cause of many bilge-equipment failures, the water and sludge, and does so with a next-generation wireless design that integrates and eliminates multitudes of components, wires, and potential points of failure. Nevata implores advanced anti-slosh logic, a pump watchdog, and a multitude of other features designed to increase reliability and safety in the bilge.

Nevata “sees” the waterline and learns the electrical characteristics of the attached pump, so it’s like having a first mate sitting and watching the bilge at all times. A dual-pump Nevata can even auto-switch pumps when one pump doesn’t work or is ineffective at removing water.

Every week Nevata will test the attached pump(s) to ensure they turn on as expected, which is very useful in identifying corrosion on connectors as a result of submerged connections, making sure the pump stays active and doesn’t sit idle too long, and helps prevent against unexpected pump failures that would otherwise go undetected.

Most bilge issues start with a developing leak, and with Nevata and Insight, the system learns how often the pumps usually cycle, and can identify a leak forming in the very early stages. When a boat is sitting unattended, the amount of water in the bilge is a good data point, but a more critical data point is knowing when all of a sudden, a pump has cycled three times in an hour when it usually only cycles once every other day. Detecting an issue ahead of a high-water condition, while the bilge system is still operational, is key to preventing catastrophic losses. After all, high-water alerts only let you know once a boat is sinking, a developing issue has transpired, and now the bilge system has failed, with no useful information. All Nevata notifications deliver detailed information, **which also includes the exact water level**, so you can make an informed decision of how to react.

A customizable runtime fault can notify of continuous pump operation, in the event incoming water is overpowering the pump’s capacity. On dual-pump Nevatas, a larger backup pump can be connected and Nevata will auto-switch to that pump if the primary pump is deemed inadequate. Likewise, if a blockage occurs, and the pump is ineffective at removing water, Nevata will auto-switch pumps and warn of pump trouble if the other pump is effective at removing water. This feature is useful for detecting jammed impellers, outlets, or other such scenarios. In this case, Nevata will not run one pump forever waiting for water to be removed, burning up the pump or otherwise wasting valuable battery capacity needed to run the backup pump. Nevata also warns of high water, but also supports an additional higher critical water threshold that can notify a harbor master or third party when an immediate pump out is needed.

With Nautic Alert’s advanced cloud solution, even more advanced analytics are possible*, such as premature pump failure detection based on pump current consumption and total accumulated pump runtime, detection of pump degradation based on the pump cycle periods taking longer and longer to remove water, and other advanced notifications and analytics that contribute to Nevata being the most advanced bilge controller ever created. *- Cloud feature coming soon.

Nevata Features

| Hardware Features | Nevata -1 | Nevata -2 | Others |
|--|-----------|-----------|------------------|
| All components out of water/sludge | X | X | |
| Wireless Connectivity | X | X | |
| Pump Watchdog | X | X | |
| Anti-Slosh Pump Drive Logic | X | X | |
| Integrated Manual Override | X | X | Standalone |
| Integrated Custom Solid State Pump Switches | X | X | Standalone/fixed |
| Integrated Pump Cycle Counters | X | X | Standalone/fixed |
| Integrated Custom High Water Detection | X | X | Standalone/fixed |
| Integrated Critical Water/3 rd Party Notify | X | X | |
| Integrated Pump Runtime Counters | X | X | |
| Integrated Pump Max Current Stats | X | X | |
| Primary/Backup Pump Auto-Switching | X | X | |
| Works with external backup float and override | X | X | |

| Normal Detection Features | Nevata -1 | Nevata -2 | Others |
|--|-----------|-----------|------------------|
| High Precision Water Level (1/10 inch) | X | X | |
| High Water Detection | X | X | Standalone/fixed |
| Critical High Water | X | X | |
| Nevata Offline Detection | X | X | |

| Early Detection Features | Nevata -1 | Nevata -2 | Others |
|--|-----------|-----------|--------|
| Weekly Pump Test | X | X | |
| Developing Leak Detection/High Pump Activity | X | X | |
| Pump Runtime Detection | X | X | |
| Pump Failure Fault Detection | X | X | |
| Pump Overcurrent Fault Detection | X | X | |
| Pump Plumbing Trouble Detection | | X | |
| Pump Failure/Trouble Auto-Switching | | X | |

| Advanced Analytic Cloud Features | Nevata -1 | Nevata -2 | Others |
|--|-----------|-----------|--------|
| Pump runtime/cycles trending predictive fail | X | X | |
| Pump current trending predictive fail detect | X | X | |
| Pump/Plumbing degradation detection | X | X | |

*Advanced Analytic Cloud Features coming soon.

Nevata Introduction

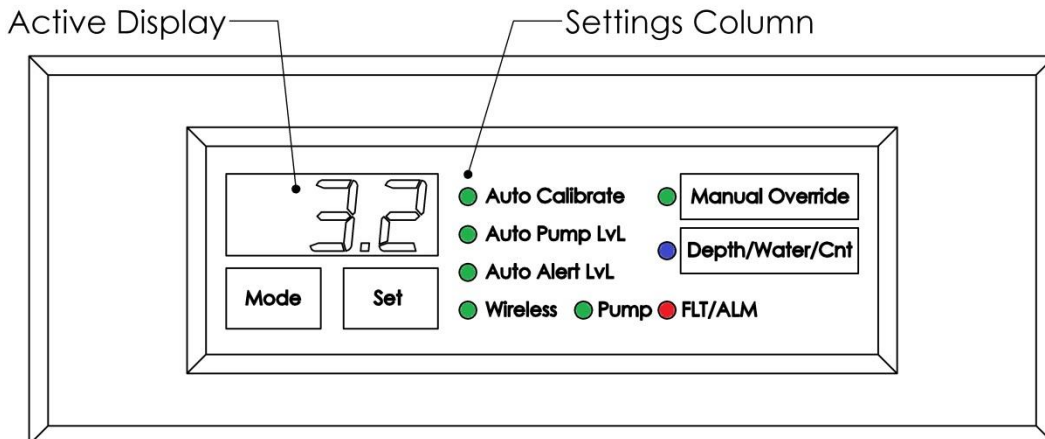

Mode/Set Button: Used to toggle through and modify Nevata's settings. Nevata's settings include:

- Auto Calibrate-used to calibrate and set the "zero" inch mark of liquid in the bilge area to be measured, once Nevata has been mounted in a fixed location.
- Auto Pump LvL-the number of liquid inches measured before activating the attached bilge pump. Requires Nevata calibration.
- Auto Alert LvL-the number of liquid inches measured before activating siren. Requires Nevata calibration.
- Wireless- enable (green), and disable (red) Wireless Sync .

Pressing mode will toggle through the above settings. A blinking setting LED indicates that setting is currently selected. Pressing set will change the selected settings' value.

Manual Override Button: Used to manually power the attached bilge pump(s). A solid/blinking green LED indicates the primary/backup pump is active

Depth/Water/Cnt Button: Toggles between displaying the depth (yellow) (distance between the Nevata and measured obstacle in inches), the water level (blue) (the amount of measured liquid in inches), and counter mode, meaning the total count of pump activations (yellow and blue). Water level and counter mode can only be displayed once Nevata has been successfully calibrated. The pump counter(s) can be reset by activating the manual override while in counter mode.

FLT/ALARM: Fault and alarm indicator. Used to indicate a fault condition (solid red) such as a failed bilge pump, invalid reading, etc..., or high water alarm condition (blinking red)

Pump: Indicates the actual pump status. Solid green if the pump is active and drawing power.

Note: Additional settings and values can be accessed from Insight and are not accessible from Nevata's display. See Insight's instruction manual for a description of these, which includes total pump cycles, runtime seconds, max current consumption, and additional settings that effect operation.

Nevata Wiring For Refit Installations

Nevata is designed to replace or work in combination with a float switch and/or external manual override. Nevata contains a built-in manual override, however, it may be preferred to keep the existing toggle switch as a backup to Nevata and Insight's wireless Nevata interface. When replacing a float, Nevata will use the same wiring as a float. Otherwise, Nevata can be wire-Ord in parallel with a float as discussed below.

If a dual-pump Nevata is used, both pumps must be co-located at the same elevation. On dual-pump Nevatas, Insight's wireless Nevata interface can be used to disable secondary pump operation, if desired.



Optional backup float switch elevated at least 3 inches minimum and higher than Nevata's critical alert level

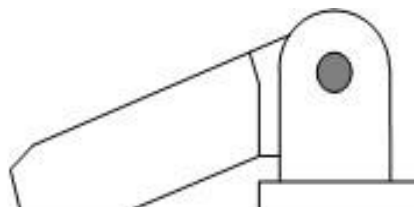

Optional backup pump at **same elevation** as primary.
Can be different capacity.

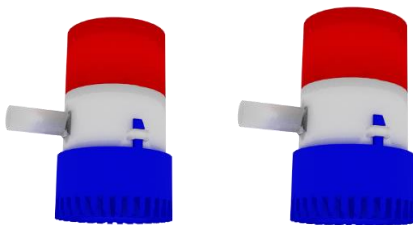

Nevata High Water Critical Alert Level



Nevata High Water Alert Level



Nevata Pump Activation Level



Simplified Schematic

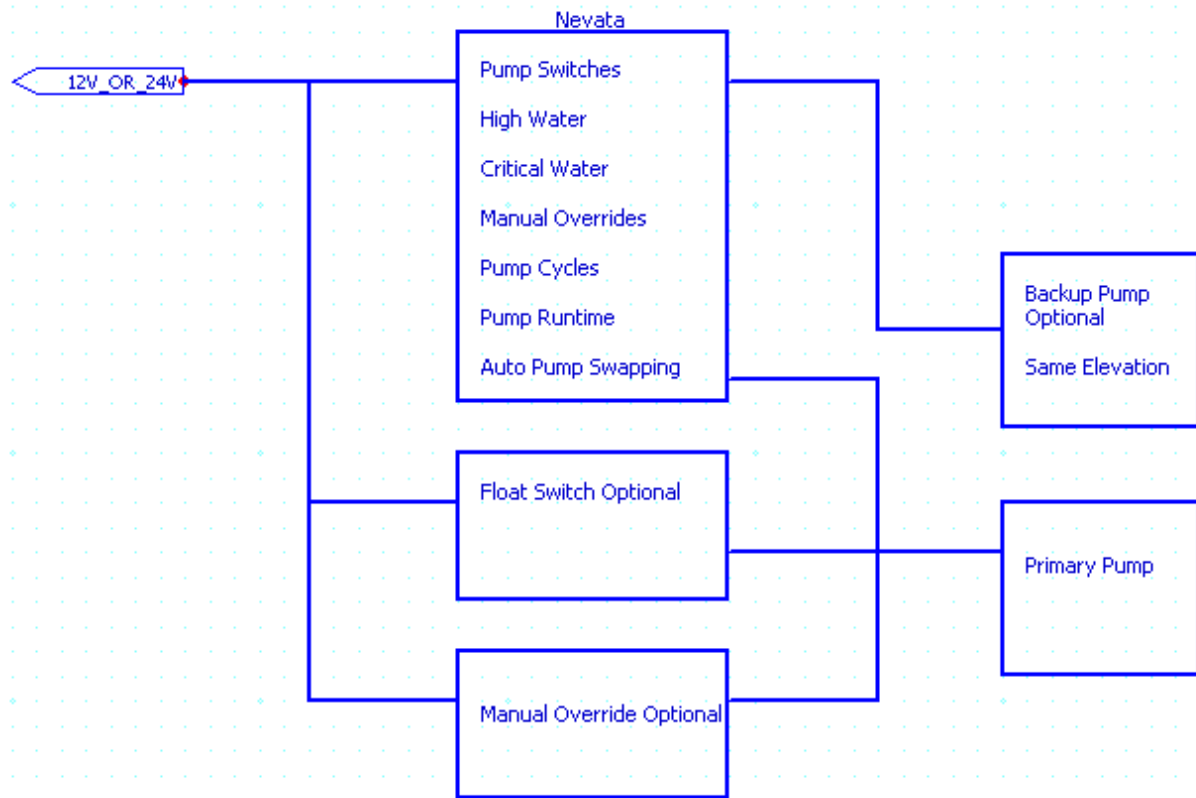

Here, multiple **optional** elevated floats **and/or** manual override switches can be wired in parallel to the attached pump(s), if already available on a refit install.

A single-pump Nevata will only operate a primary pump.

A dual-pump Nevata can operate both a primary and backup pump co-located at the same elevation, or can be setup to act as a single pump Nevata via Insight's Advanced Nevata Settings Screen shown below.

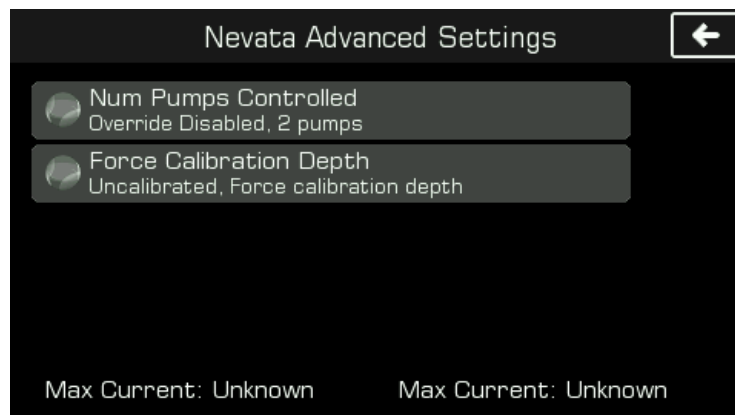

Step 2- Wire Nevata's DC leads to your boat's electrical system

The use of waterproof butt connectors and an inline fuse is recommended.

Note: Connect the DC cable's red wire to your positive source, and the black wire to ground.

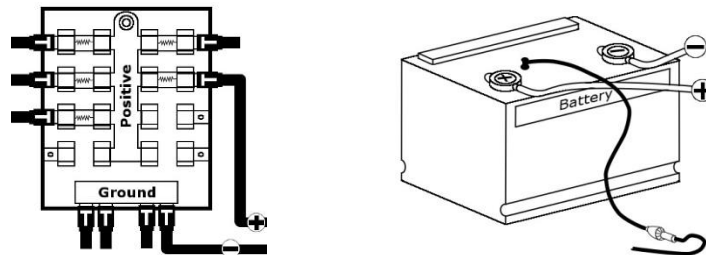

Elevate all of the cable connections such that water immersion is less likely. These should be higher than the bilge pump at a minimum, and at a lower elevation than Nevata.

Once the DC wires are connected to the power source, the display will light up with “000”, followed by the firmware version installed on the device, which will show for a few seconds. There will also be an audible beep tone to indicate the device is operational.

Note: It is required to adhere to ABYC or USCG wiring standards depending on the type of boat being used.

Step 3A- Mounting And Calibrating Nevata With a Flat Bottom Bilge

Attempt to locate a mounting position over the deepest part of the bilge where the pumps will reside prior to permanently mounting Nevata.

WARNING: Ensure the bilge area is dry and does not contain any liquids before performing this step. If it is not, activate the manual override and leave the pump running during this step, such that minimal water is present.

Ensure a stable depth reading is observed over several seconds before choosing a permanent mounting location.

A depth reading of around 12 inches is preferable for optimal performance, although Nevata will operate from 4 to about 32 inches.

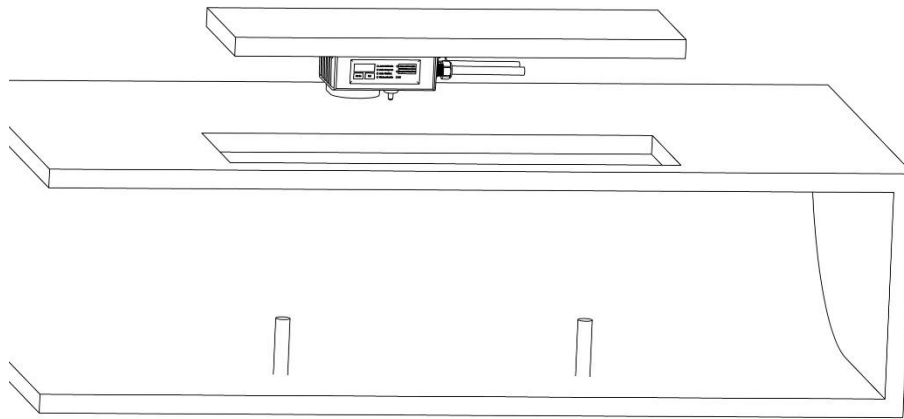

Mounting Nevata Diagram

Note: Locate a position that does not interfere with objects such as keel bolts, and provides a true measurement to the floor of the bilge and base of the attached pumps, rather than the top side of a bilge pump, keel bolt, etc... The farther away from obstructive objects, the better.

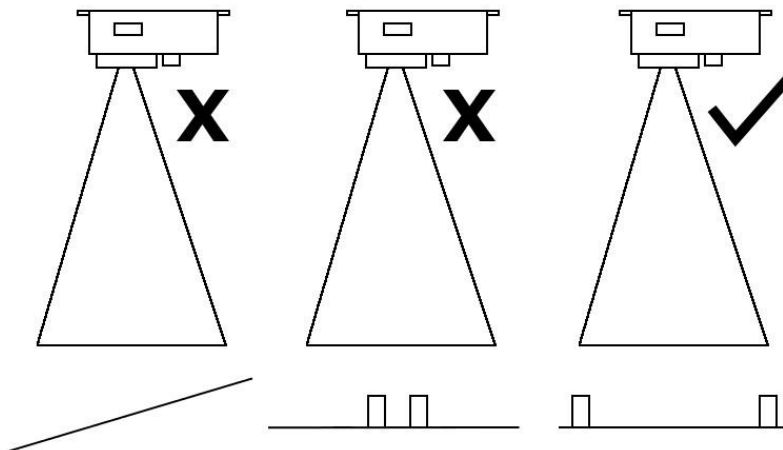

The first time your Nevata pairs with Insight, you will be prompted to quick configure your Nevata as shown below on Insight:

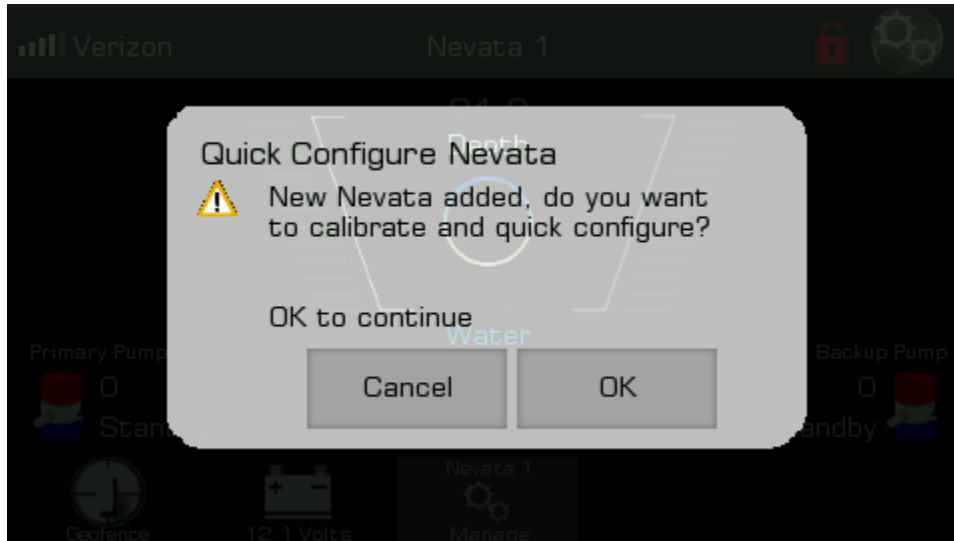

Hitting continue will calibrate Nevata and apply all default Nevata settings. If this step is skipped or not available, use the Nevata Remote View on Insight or Nevata’s display interface to calibrate Nevata as shown below.

Press the “mode” button to select “Auto Calibrate”, and the “Auto Calibrate” LED will begin blinking to show you are in the calibrate state. On Nevata, once you hit “set”, the 30 second count down will begin. Within this time, it is necessary to mount Nevata in its permanent mounting location prior to time expiring. The final 5 seconds will emit a double beep. If using Insight, there will be no countdown timer.

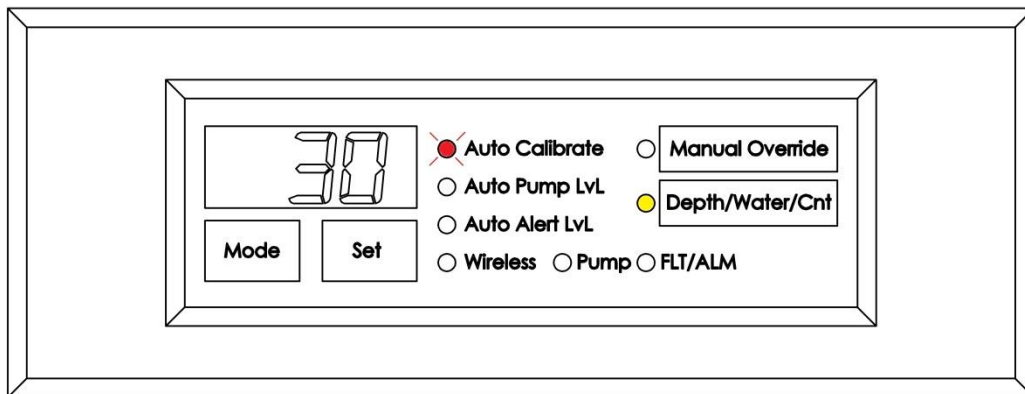

The calibration process will power on each attached bilge pump during this operation.

Note: Nevata must be recalibrated if either pump is replaced.

Note: This calibration step can always be repeated if, for example, the mounting location changes or count down expires prior to mounting Nevata properly.

At the end of the countdown sequence, the beep tones will stop and the “Auto Calibrate” LED will remain steady green to indicate the calibration was successful, and the display has returned to showing the run mode. **That’s it, your Nevata is now operational with the default settings.**

If the calibration sequence was unsuccessful, on a Nautic Alert Insight, the reason calibration failed will be displayed.

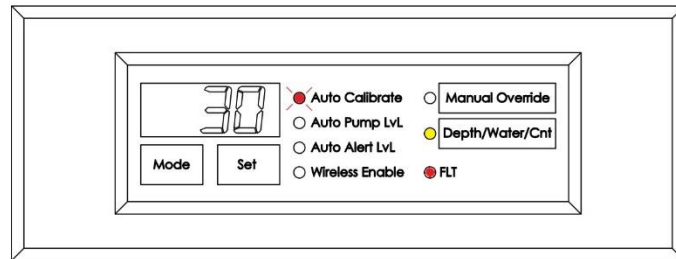

See the troubleshooting section for reasons why the calibration sequence may fail. Once you have corrected the problem, pressing “set” will restart the calibration sequence to attempt calibration again.

3B- Mounting and Calibrating Nevata Without a Flat Bottom Bilge

If Nevata does not display a steady depth reading when attempting to measure the bottom of the dry bilge, it is possible to manually set the depth distance between Nevata's mounted position and the zero-inch water mark as shown below.

Measure the distance from the lowest point of Nevata's cone to the bottom of the bilge where the presence of water will create a flat surface large enough to account for a 30 degree beam angle in all directions from Nevata's cone as shown below. A smooth-hard surface object cutout can be used additionally to verify the measurement and provide a displayed depth reading, or can permanently be put in place to allow calibration under step 3A above.

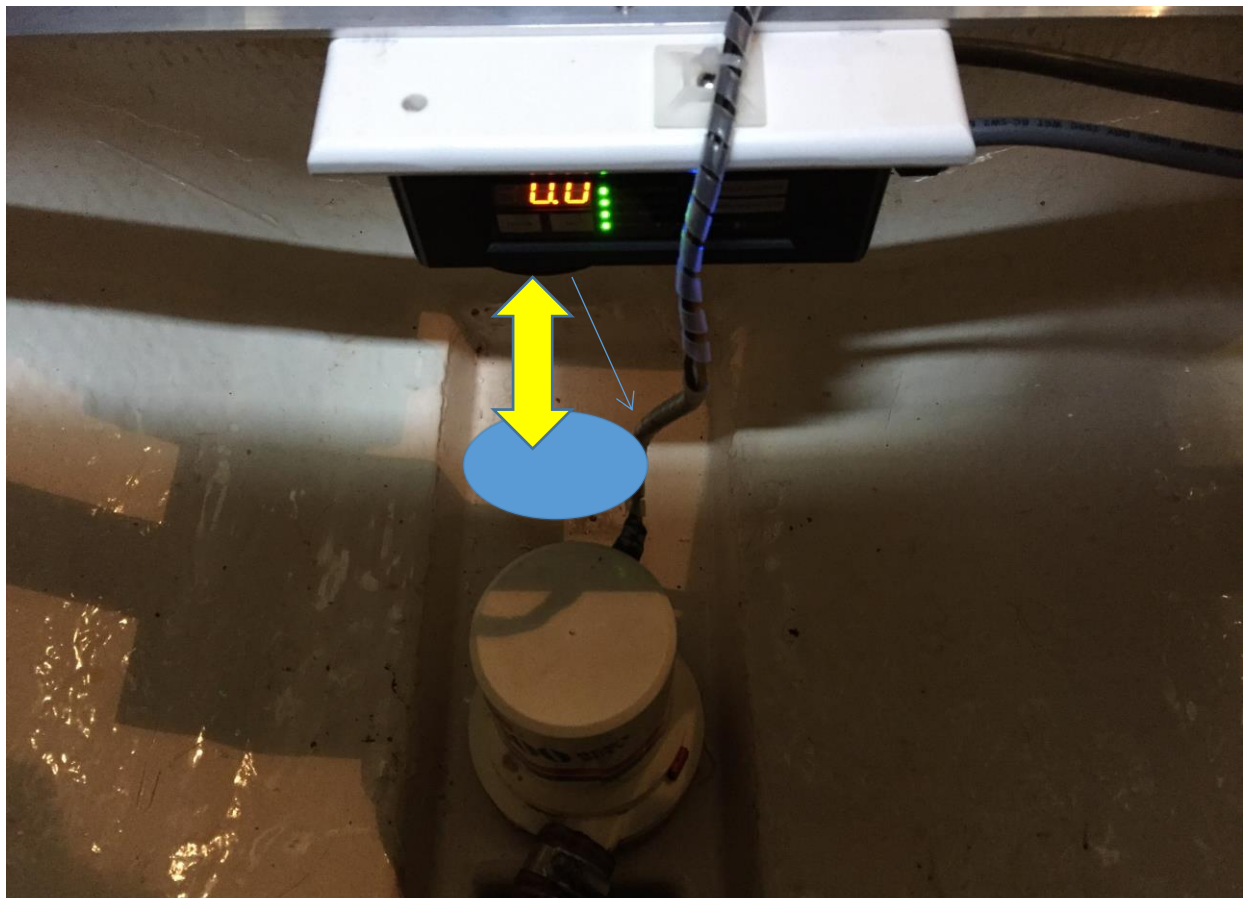
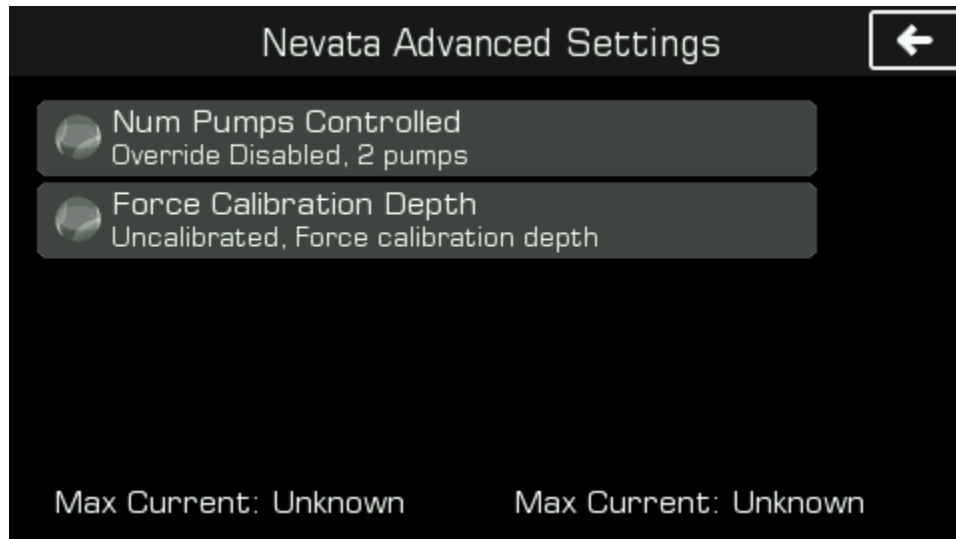
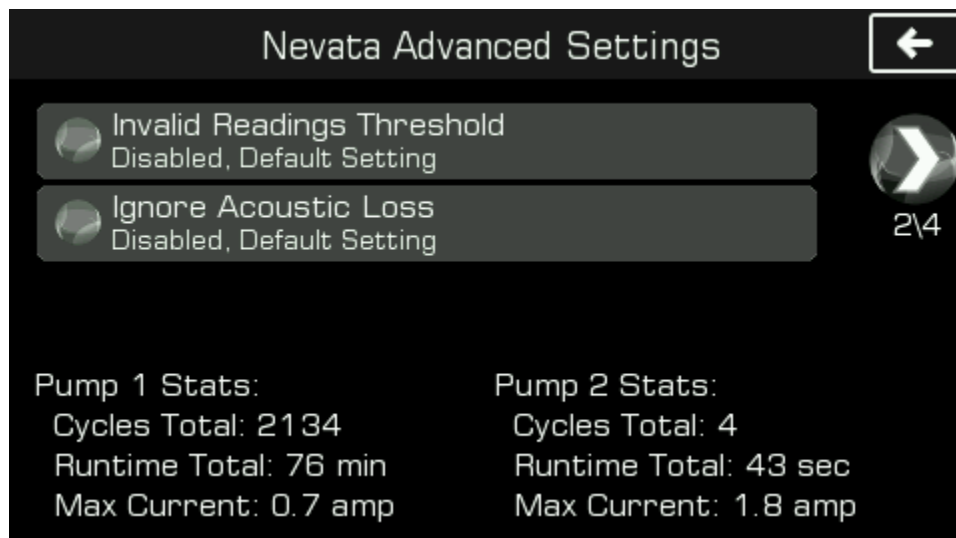

Image for illustration only and does not represent a non-flat bottom scenario.

Next, navigate to Insight’s Advanced Nevata Settings Screen (See Insight Manual for reference) as shown below:



Select “Force Calibration Depth” and enter the measured distance. During this step, the “Ignore Acoustic Signal Loss” option will be enabled as shown below. Note, these additional settings are only accessible once Nevata has been successfully calibrated.



[Ignore Acoustic Loss](#)

When “Ignore Acoustic Loss” is disabled, Nevata will report a loss of water readings to Insight, which will send a signal loss fault event notification. Additionally, Nevata will automatically periodically cycle the attached pump and test for the presence of water using its learned pump abilities.

With this setting enabled, Nevata will treat the dry bilge condition as normal and wait for the presence of water to obtain a water-level reading and activate the pump. Nevata will not send a notification or periodically cycle the pump, other than the weekly pump test or when a valid water level is present.

Customizing Settings

After Nevata has been successfully calibrated, default values have been assigned for the bilge pump level threshold, and the alert level threshold. (See the *Nevata Introduction* section for descriptions of these). To manually modify the default values, press “Mode” to select the setting, then press “Set” to change the value.

Wireless Sync Functionality

Note: It is highly recommended to disable Wireless Sync  if a Nautic Alert Insight system is not being used with your Nevata, to prevent another Insight system from communicating and controlling it.

Note: By default, your Nevata will search for an Insight system to communicate with. Once your Nevata is paired to your Nautic Alert Insight, it will only communicate with that system. In the event your Nevata needs to be re-paired with another Insight, a factory reset operation may be required. See the “Factory Reset” section for instructions on how to do this. Alternatively, unpairing Nevata from a Nautic Alert Insight will cause Nevata to actively look for another Insight to pair with, thus, a reset defaults will not be required in this case.

Fault Indication

The “FLT” LED will remain solid red if a fault is detected. In addition, the audible alert will chirp once a minute while a fault is present.

A fault indication can occur for any of the following reasons:

- Problem powering attached bilge pump
- Trouble condition detected
- Transducer signal blockage (if “Ignore Acoustic Loss” is disabled)
- Nevata is out-of-range or no longer receiving a reflected signal once Nevata has been calibrated.
- An attempted calibration failed
- A pump has been actively running continuously for too long (30 minutes)

A fault indication will be removed automatically within 2-3 seconds of remedying the issue.

If Nevata attempts to power on the bilge pump, either automatically or due to the manual override, and the bilge pump is not detected to power on within several seconds, a fault will occur. This fault will remain, even after a complete power loss of Nevata, until the pump is successfully powered on.

Once a faulty bilge pump has been remedied, activating the manual override will clear a fault due to this condition if the pump powers on successfully. **If a bilge pump is replaced, a calibration sequence must be rerun.**

Note: The audible alert will also chirp once a minute if the manual override is active.

Note: If your Nevata supports a backup pump, the fault can be due to a backup pump failure as well.

Safety Features

In the event a total submersion of Nevata occurs, or if the measured signal is lost while Nevata is calibrated, Nevata will automatically activate the attached bilge pump by default, unless the “Ignore Acoustic Loss” or “Invalid Readings Threshold” setting has been enabled.

Note: See *Insight’s Advanced Nevata Settings* for additional information on optional settings.

Periodic Pump Check

In the event the primary or backup pump (on dual pump models) is not activated within a 7 day period, Nevata will automatically power-up the pump for a few seconds to validate the pump powers on successfully.

Factory Reset

A factory reset should only be necessary if you wish to re-pair your Nevata to another Nautic Alert Insight, where the Insight is no longer available to unpair the device remotely.

To begin the factory reset, press “Set” while holding down the “Mode” button. When this is done properly, the display will turn off, followed by a long beep tone.

Once this process completes, the display will become active, the beeping will stop, and Nevata will be uncalibrated. At this time, Nevata will be actively searching for a Nautic Alert Insight system to communicate with.

Total Pump Cycles and Runtime

Nevata keeps track of the total pump cycles and runtime seconds of each pump. These values can be read from the Advanced Nevata Settings screen on Insight, and are not accessible from the Nevata display. Additionally, both settings can be set in Insight’s Advanced Nevata Settings screen as shown below.

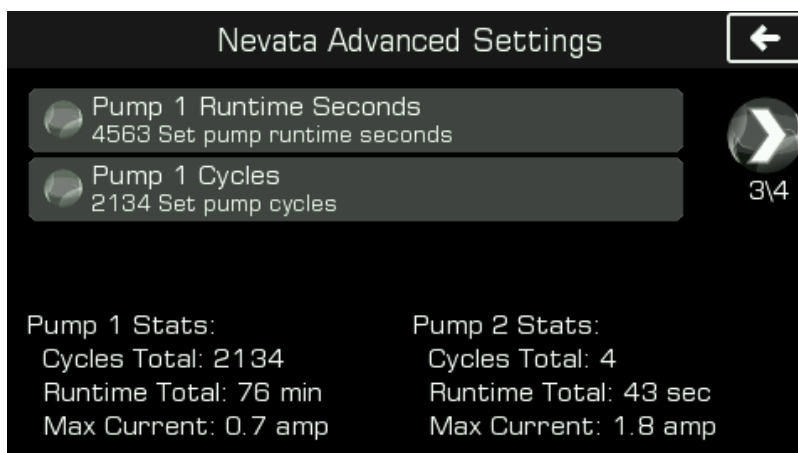

Note: The cycles shown here are the total accumulated cycles, and **may be different from the pump cycles shown from the Nevata’s count function**, which is intended to be periodically reset to give an indication of how often the pumps are cycling over time.

Invalid Water Level Threshold For Refit Installs

Once calibrated, Nevata can ignore any water level readings above the critical water level threshold, if desired, as shown below with the “Invalid Readings Threshold” setting. This setting can be set to any depth greater than the critical alert threshold and the total installed depth available at one inch increments:

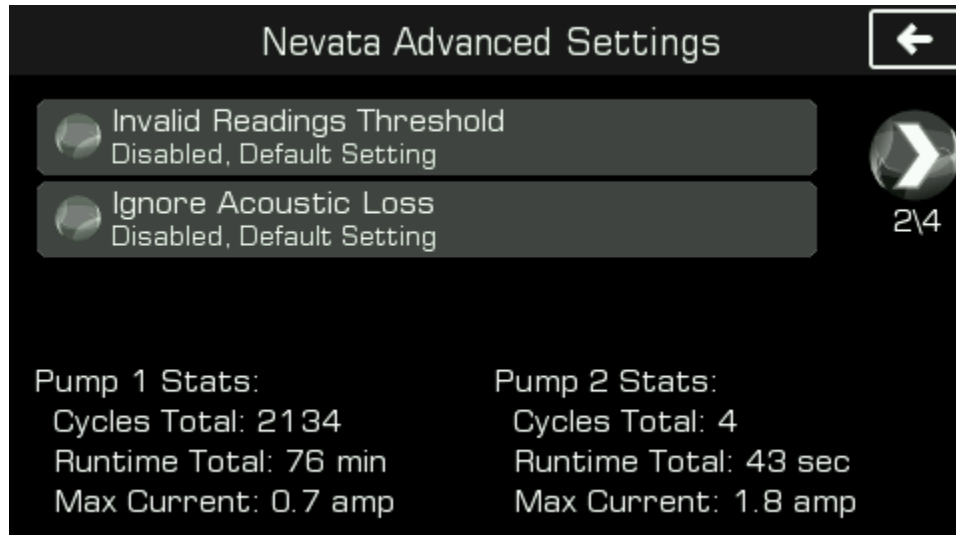

This feature can be particularly useful if using an elevated backup float switch, and you wish to prevent Nevata from attempting to simultaneously power an attached pump, which would create a pump fault condition since no current would flow through Nevata’s internal pump switches.

External Voltage Sense

If using a backup float switch or external manual override, Nevata will sense the presence of an external source driving the pump, and increment the runtime totals for each attached pump automatically. An external voltage presence will not change the pump cycle counters.

Insight's Nevata Display Quick Summary

Additional screen details can be accessed in Insight's instruction manual.

Nevata View

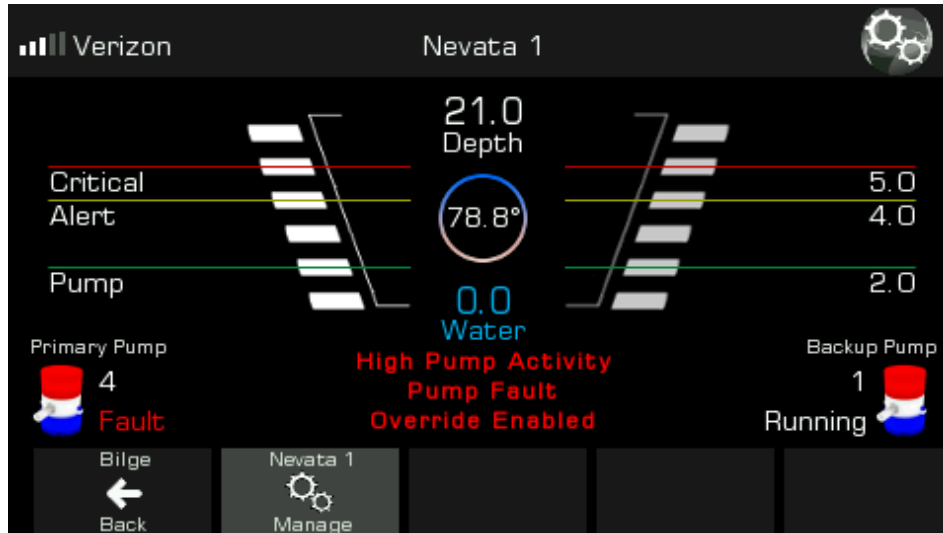

The Nevata display provides a high-level description of Nevata's settings, pump details, and any faults.

Nevata Remote View

The Nevata Remote View provides a 2-way bi-directional wireless Sync interface between Insight and Nevata. Additionally, this is where the continuous pump runtime setting and critical alert threshold are set.



High Pump Activity Settings

Your Insight will keep track of pump usage statistics, and notify you in the event a bilge pump is being used more than nominal. This is very useful for detecting a leak in the early stages of development.

These settings are accessed by pressing a pump icon from the Insight View.

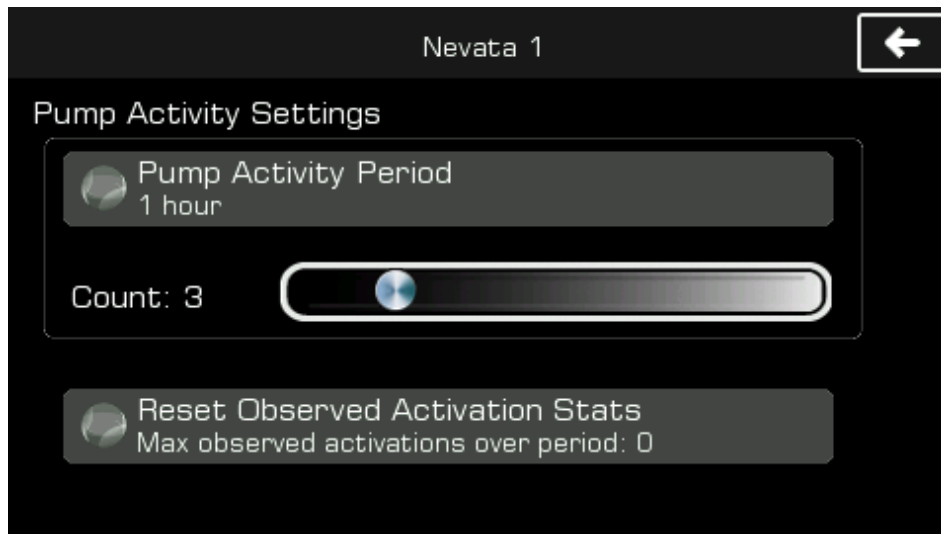

Additional Considerations

Avoid contact with degreasers and chemicals, as these can degrade the performance of Nevata.

Nevata is not intended to be used as a life saving device.

Product Warranty Information

Visit docs.nauticalert.com for product registration and warranty information.

Troubleshooting

Nevata will not power on

- Verify Nevata is connected to the DC electrical system, and the DC electrical system is at a proper voltage level
- Verify any in-line fuses are not blown between Nevata and the DC battery, and any applicable panel switches are turned on.
- Verify proper wiring polarity of the Nevata's DC cable assembly to the correct +/- DC electrical connections
- Verify waterproof connectors have been used with Nevata's DC connections, and that water submersion to the connectors has not corroded the wiring inside of the connector.

Nevata will not calibrate

- While Nevata is in the run mode, ensure that an adequate depth is present and visible on the active display when in depth mode, between 4 and 32 inches, and that this depth makes sense. Verify all the conditions are met per notes in the "Mounting Nevata" section
- Ensure no other ultrasonic device is within close proximity of your Nevata, as this can cause interference and false depth/water level readings
- Ensure both the primary and backup (if your Nevata supports two pumps) are connected, as they must power on properly during the calibration sequence.
- Distance electrical cables from proximity of Nevata's power path to the battery in case other electrical interference is interfering.

Bilge pump turns on too frequently

- Increase the bilge pump turn on threshold (See the *Nevata Introduction*)
- Remove electrical cables from proximity of Nevata in case electrical interference is causing false depth/water level readings
- Ensure no other ultrasonic device is within close proximity of your Nevata, as this can cause interference and false depth/water level readings
- Recalibrate Nevata to reset "zero" inch mark. See section "Calibrating Nevata"

Bilge pump turns on improperly

- A sudden change in temperature could falsely alter the depth and water level reading of your sensor. If the sensor is located in the path of draft currents, try increasing the pump turn on level or prevent sudden temperature drafts
- Ensure the temperature probe next to the transducer cone is free to operate in open air, and not influenced by any artificial heat or cold drafts
- Check the transducers to ensure there are no obstructions on or around their face, or in the cone. Ensure that any liquid that splashes onto the transducers is removed.
- Ensure that the depth your Nevata is mounted at is optimal to avoid splashing and contamination into the cone region.

- If your Nevata is mounted at a far depth (> 20 inches), try reducing the depth and recalibrating.

Sensor resets continuously

- Ensure the length and size of the overall cable run from the Nevata to the boat's power source is sufficient for the load requirements of the bilge pump. When the bilge pump turns on, it will typically consume a large amount of current initially, which may cause a sudden voltage drop at the DC input to your Nevata sensor. If this occurs, Nevata will reset itself as a safety precaution, if the voltage drops less than the minimum required. A 24V DC system can provide the same amount of power as a 12V system, at half of the current that a 12V system would require. Larger bilge pumps, or pumps requiring long power cable runs will work more efficiently at higher voltages and reduce the voltage drop-out.

Fault indication is present

- See section "Fault indication" for possible reasons
- Check connection on bilge pump
- Activate manual override to ensure bilge pump(s) operates as expected
- Switch to depth mode and ensure depth measurement makes sense and is stable. See section "Depth and water level"
- Check for residue on the transducer face to ensure there is no blockage
- Ensure a flat surface is available at the bottom of the compartment being measured
- Ensure the min and max depth requirements are being met—4 to 32 inches

Nevata is not in the expected state during an initial calibration/install, or I want to factory reset

- See section "Mounting Nevata" for a description of how to select the calibration mode, if the calibration mode is not selected
- See section "Factory Reset"

Additional Information

For support questions, please visit the Nautic Alert knowledgebase at docs.nauticalalert.com or send an email to support@nauticalalert.com.

If you wish to speak with us, you can reach us at 800-385-1674.

