

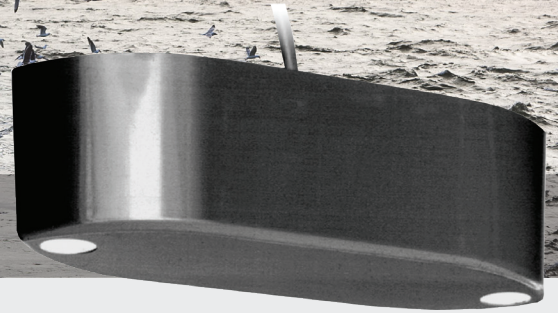

M188LH / M180

Dual Frequency 1 kW - 2 kW Transducers



- Direct retrofit transducer with same shape and form as Combi C/D models
- For use with Chirp mode echo sounders or CW echo sounders of various brands
- Standard delivery with 20 m (65') C44-02 transducer cable

M188LH Broadband Chirp-Ready Transducer

Provides excellent fish discrimination and bottom detail

- 30-60 kHz:
 - 2 kW
 - 10°port/18°starboard beamwidth at the center of the band
- 130-210 kHz:
 - 1 kW
 - 11°-6° beam
- Operates in both Chirp mode or at any discrete frequency in the band.
- Covers popular frequencies such as 38 kHz, 50 kHz and 200 kHz
- XducerID® technology

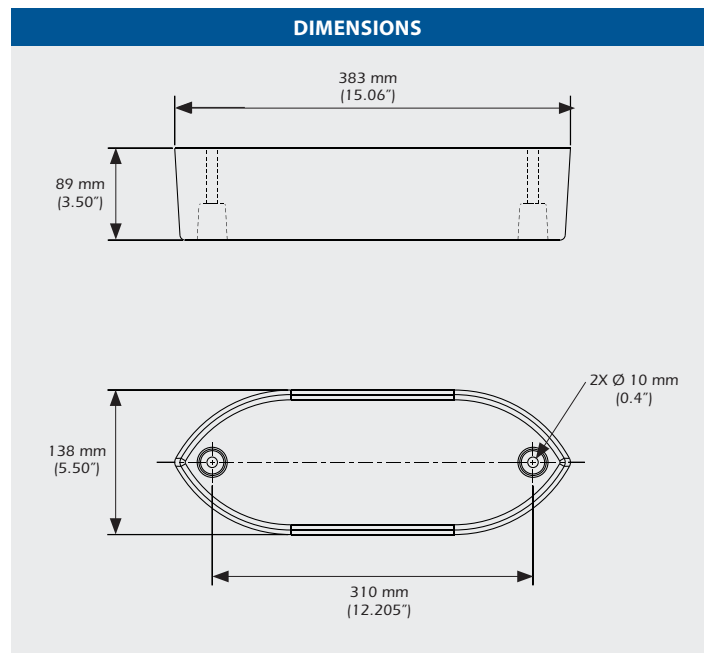

M180 CW Conventional Transducer

Low Q design provides good target separation and bottom detail

- 50 kHz:
 - 2 kW
 - 9° X 19° elliptical beam
- 200 kHz:
 - 1 kW
 - 6° beam
- XducerID® technology

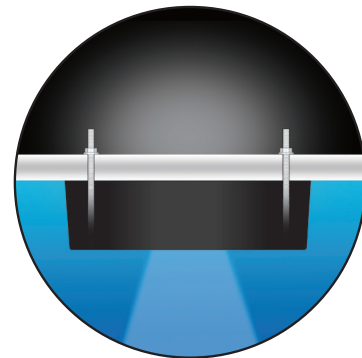

M188LH Chirp-Ready

M188LH SPECIFICATIONS				
Frequencies	RMS Power	Impedence	At Center of Frequency Band	Configuration
Low 30-60 kHz	2 kW	100 Ω	8° X 18°	
High 130- 210 kHz	1 kW	100 Ω	8°	

Technical Data – 30 kHz to 60 kHz

TVR in dB re 1μPa/Volt at 1 m

RVR in dB re 1 Volt/μPa

Technical Data – 130 kHz to 210 kHz

TVR in dB re 1μPa/Volt at 1 m

RVR in dB re 1 Volt/μPa

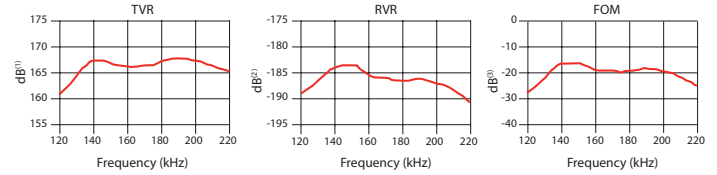
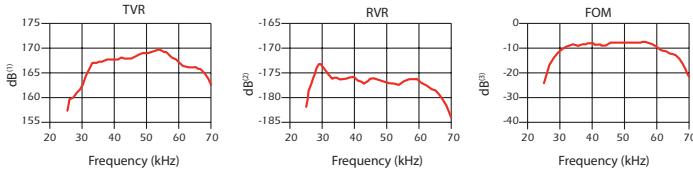

Directivity Pattern

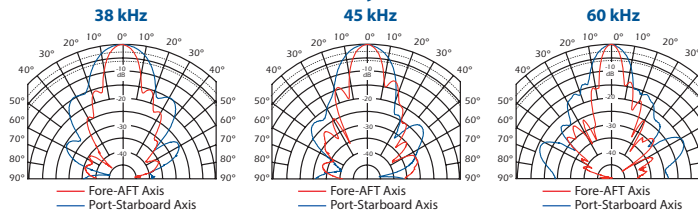

Directivity Pattern

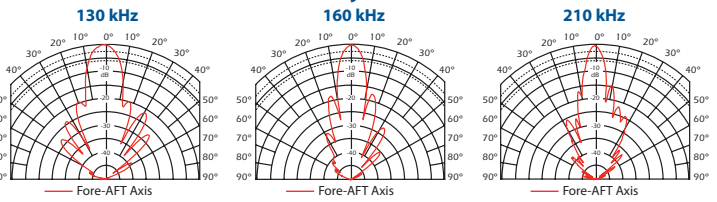

M180 – CW

M180 SPECIFICATIONS				
Frequency	RMS Power	Impedence	Beamwidth	Configuration
50 kHz	2 kW	140 Ω	9° X 19°	
200 kHz	1 kW	90 Ω	6°	

Technical Data – 50 kHz

TVR in dB re 1μPa/Volt at 1 m

RVR in dB re 1 Volt/μPa

Technical Data – 200 kHz

TVR in dB re 1μPa/Volt at 1 m

RVR in dB re 1 Volt/μPa

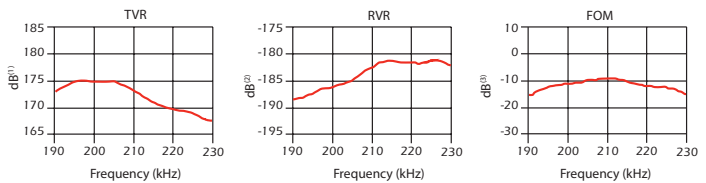
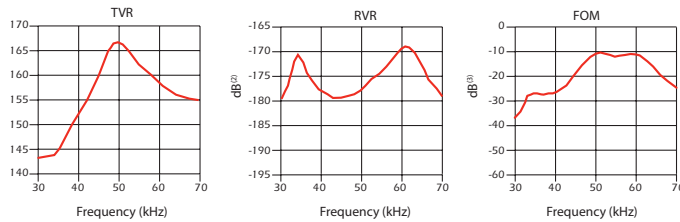

Directivity Pattern

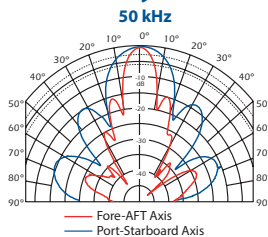

Directivity Pattern

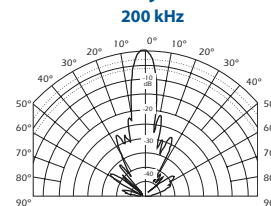

www.airmar.com

©2019 Airmar Technology Corporation



M188LH/M180_DS_rB 2/14/19

As Airmar constantly improves its products, all specifications are subject to change without notice. All Airmar products are designed to provide high levels of accuracy and reliability, however they should only be used as aids to navigation and not as a replacement for traditional navigation aids and techniques. Other company or product names mentioned in this document may be trademarks or registered trademarks of their respective companies, which are not affiliated with Airmar.

