



MP300 PRINTER Operator's Manual







Read this document carefully to use this product safely and correctly. If your product is faulty, please read the warranty card on the website and contact the store you purchased it from. If you require further assistance, contact your local customer service.

Please also visit us at www.panduit.com for help and support. You can download the latest version of this Operator's Manual from the website.

Content menu

Specifications.....	2
Using the printer with Easy-Mark Plus.....	3
Troubleshooting	4
Part Names and Functions	5
Start Here	7
Cleaning.....	14
Initializing the Settings	15
Label Functions.....	16
Key Menu Index	44
Frame and Table Lists.....	62
Symbol List	64
Technical Support	66

Notation used in this manual

 WARNING	Indicates information that, if ignored, could possibly result in serious personal injury or even death due to incorrect handling.
 CAUTION	Indicates information that, if ignored, could possibly result in personal injury, physical damage, or damage to equipment due to incorrect handling.
Attention	Indicates important information about the printer.
MEMO	Indicates additional information and points which may be useful to know regarding a topic.
	Indicates a place with more detailed information.
	Shows an image of the label to be used as an example.
	Indicates the buttons on the printer.
"Name"	Indicates the menu items, messages shown on the display, or the name of a manual. Example: "On", "Start print?"

Specifications

Body

Dimensions (W x D x H)	Approx. 5.35 x 11.61 x 3.82 (inches)	
	Approx. 136 x 295 x 97 (mm)	
Weight	Approx. 2.76 lb	(excluding batteries, tape cartridge)
	Approx. 1,250 g	

Usage conditions

Operating temperature	5 to 35 degrees C
Storage temperature	-10 to 55 degrees C

Supported tape width

6 mm, 9 mm, 12 mm, 18 mm, 24 mm, 36 mm, 42 mm (Die-cut)

Power supply

Battery

Li-ion battery (C52CE97010) x 1 / AA alkaline battery x 6

AC adapter

Type	AST1527Z2-1
Manufacturer	Seiko Epson Corp.
Input	100-240 V AC, 1.2 A, 50-60 Hz (dedicated adapter, power cable only)
Output	15 V DC, 2.7 A
Total output power	40.5 W

Li-ion battery specifications

Ambient temperature

During operation	0 to 40 degrees C	
Charge	0 to 40 degrees C	
During storage	Less than 1 month	-20 to 50 degrees C
	Less than 3 months	-20 to 40 degrees C
	Less than 1 year	-20 to 20 degrees C

Charging information

Nominal specifications	Charging current (Std.)	1.0 A
	Charging voltage (Std.)	8.05 V
	Charging time	Approx. 3 hours
Charge limits	Battery pack model	C52CE97010
	Maximum charge current, A	1.0 A
	Maximum charge voltage, V	8.4 V

Rated time when using alkaline batteries

Rated operating time / Rated resting time	0.5 h / 1.0 h
---	---------------

Compliance/Safety regulation

For more information, see Important Safety sheet.

Top

Specifications

Using the printer with
Easy-Mark Plus

Troubleshooting

Part Names and
Functions

Start Here

Cleaning

Initializing the
Settings

Label Functions

Key Menu Index

Frame and Table Lists

Symbol List

Technical Support

Using the printer with Easy-Mark Plus

Connect the printer to a computer with the USB cable in order to print from Easy-Mark Plus Labeling Software.

For detailed instructions to install and use Easy-Mark Plus, go to www.panduit.com or contact the Panduit Identification Technical Support Group.

Visit the Panduit website to find the most current MP300 firmware upgrade file and instructions.

 "Technical Support Contact information: phone #, email. address"

Top

Specifications

Using the printer with Easy-Mark Plus

Troubleshooting

Part Names and Functions

Start Here

Cleaning

Initializing the Settings

Label Functions

Key Menu Index

Frame and Table Lists



Symbol List

Technical Support

Troubleshooting

■ Messages

This section explains the remedies when the following messages appear on the display.

Check battery Charge Li-ion!	The battery has run out of power. Connect the AC adapter to the printer and charge the battery. For details,  "Charging the Li-ion battery"
Check battery Change alkaline	The batteries have run out. Turn off the power and replace all batteries with new ones.
Cover open!	Top cover is open. Close the top cover.
Insert tape	Check if the tape cartridge is loaded or correctly set. For details,  "Installing a tape cartridge"
Check tape cartridge	The loaded tape is not supported. Insert a correct cartridge.
No more sequence No.!	Only up to 2 sequence numbers can be inserted.
No more barcode!	Only up to 2 barcodes can be inserted.
QR CODE too big!	Perform either of the following: Use a wider tape. Reduce the text or cell size. Lower "ECC Level".
Overheated!	The printhead is overheated. Turn off the power and remove the tape cartridge, then leave the printer until it cools down.
Trash at slot Remove trash	There is tape remaining in the tape eject slot. Remove the tape.
Remove cut tape	Unable to start printing because there is cut tape remaining in the tape eject slot. Remove the tape from the tape eject slot.

■ Problem

Unable to charge Li-ion battery

Is the Li-ion battery correctly installed? Check that the Li-ion battery is correctly installed.
Is the AC adapter securely connected? Connect the AC adapter and the power cable firmly to the power socket of the printer, the AC adapter connector and the outlet.

Unable to detect the tape correctly

Is the tape cartridge correctly installed? Check that the tape cartridge is correctly installed.
Is the label for detecting the tape cartridge clean? If not, wipe the dirt off with a soft cloth.
Is the detection sensor of the printer clean? If not, wipe the dirt off with a soft cloth.

MEMO

If none of the above has solved the problem or the symptom is other than the above, contact Panduit Identification Technical Support.

Top

Specifications

Using the printer with Easy-Mark Plus

Troubleshooting

Part Names and Functions

Start Here

Cleaning

Initializing the Settings

Label Functions

Key Menu Index









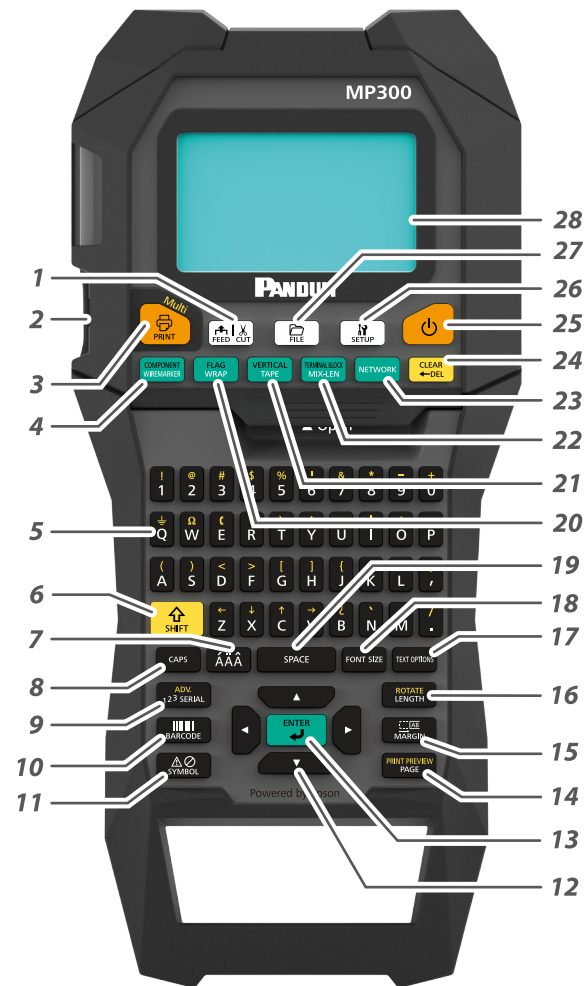

Frame and Table Lists

Symbol List

Technical Support

Part Names and Functions



1. Feeds and then cuts the tape.
2. Tape eject slot
3. Prints a label. Hold down  and press this to print with a special print function.
4. Creates a label for Wiremarker. Hold down  and press this to change to Component mode.
5. Character keys. Secondary characters can be entered by pressing  and these buttons at the same time.
6. Shift
7. Enters a character with an accent.
8. Caps lock
9. Creates a label with a serialization. Hold down  and press this to create with advanced serialization.
10. Creates a barcode label.
11. Enters a symbol.
12. Cursor keys
13. Confirms the settings.
14. Adds a page. Hold down  and press this to preview the created label.
15. Sets the margins.
16. Sets the tape length. Hold down  and press this to rotate the text.
17. Sets the format and style.
18. Changes the font size.
19. Space
20. Creates a label to wrap around cables. Hold down  and press this to create a label that wraps around cables like a flag.
21. Creates a tape label. Hold down  and press this to change to vertical mode.
22. Creates labels with mixed lengths. Hold down  and press this to change to terminal block mode.
23. Creates labels for the Patch Panel, 66-Block and 110-Block.
24. Delete. Hold down  and press this to clear all text and/or setting.
25. Turns the printer on and off.
26. Displays the setup menu.
27. Saves and recalls label files.
28. Display area.

Top

Specifications

Using the printer with Easy-Mark Plus

Troubleshooting

Part Names and Functions

Start Here

Cleaning

Initializing the Settings

Label Functions

Key Menu Index

Frame and Table Lists

Symbol List

Technical Support

■ Display

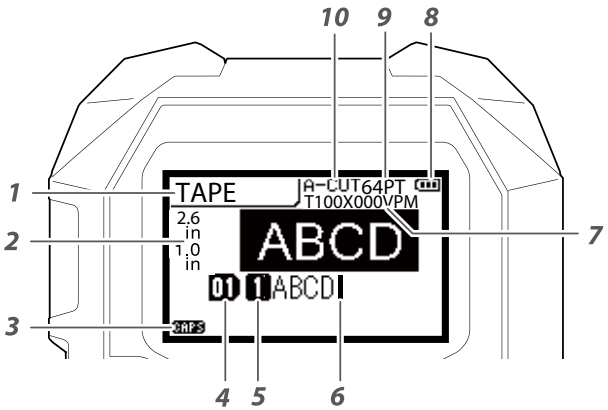

- 1. Label Mode
- 2. Current label length and width
The unit can be switched between inch and cm.
☞ "inch/cm"
- 3. Caps Lock ON
- 4. Page Number
- 5. Line Number
- 6. Cursor
- 7. Label Part Number
- 8. Battery Life
- 9. Font Size
- 10. Cutter Setting

The display shows the current settings and characters you have entered.
 You can change the language shown on the setting screen and menu.
 ☞ "Language"

- Top
- Specifications
- Using the printer with Easy-Mark Plus
- Troubleshooting
- Part Names and Functions**
- Start Here
- Cleaning
- Initializing the Settings
- Label Functions
- Key Menu Index
- Frame and Table Lists
- Symbol List
- Technical Support

Start Here

1. Installing the Li-ion battery

Before using the printer for the first time, charge the Li-ion battery (C52CE97010). Read also the safety precautions for the rechargeable battery described in this manual.

For details on handling the Li-ion battery, refer to the manual included with the battery.

⚠ WARNING

Be sure to use the dedicated Li-ion battery (C52CE97010). Using a battery other than the one specified may cause fire, explosion, leakage, overheating or other damage.

⚠ CAUTION

When disposing of used batteries, make sure to follow the regulations.

1. Open the battery cover.

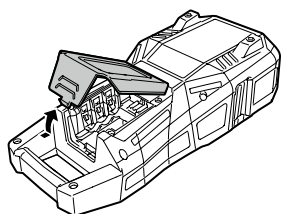

2. Install the Li-ion battery in the correct orientation.

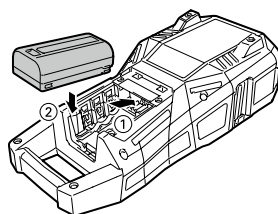

3. Close the battery cover.

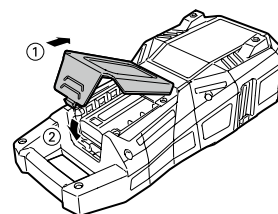

■ Charging the Li-ion battery

You can charge the dedicated Li-ion battery (C52CE97010) with the printer.

To charge the battery, connect the AC adapter to the printer with the Li-ion battery installed.

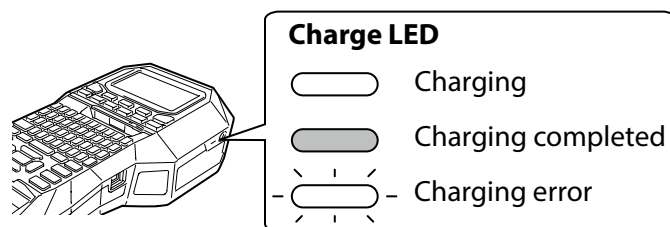

MEMO

- The Li-ion battery cannot be charged while printing.
- When the power of the charged Li-ion battery seems to run out quickly, replace it with a new one.
- There is likely to be a charging error or battery error in the following cases. Contact qualified service personnel.
 - The charge LED flashes during charging.
 - New Li-ion battery takes significantly longer to charge than the estimated charging time (less than 3 hours).

Top

Specifications

Using the printer with Easy-Mark Plus

Troubleshooting

Part Names and Functions

Start Here

Cleaning

Initializing the Settings

Label Functions

Key Menu Index

Frame and Table Lists

Symbol List

Technical Support

■ **Using alkaline batteries**

You can use alkaline batteries instead of the Li-ion battery. When using alkaline batteries, install them in the correct orientation.

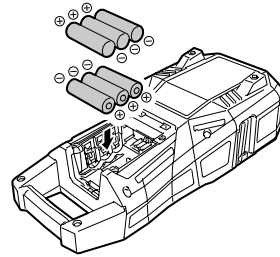

CAUTION

When you have printed continuously for 30 minutes using alkaline batteries, leave the printer for at least one hour to allow the batteries to cool down.

■ **Connecting the AC adapter**

Connect the AC adapter as shown below.

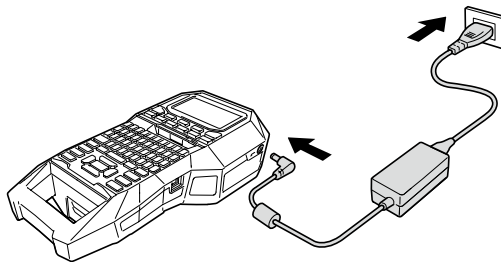

■ **Connecting the Computer**

1. **Connect the USB cable to the printer.**
2. **Connect the other connector of the USB cable to the computer.**

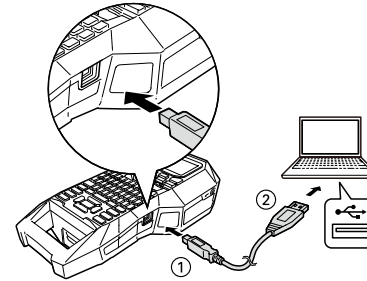

Top

Specifications

Using the printer with Easy-Mark Plus

Troubleshooting

Part Names and Functions

Start Here

Cleaning

Initializing the Settings

Label Functions

Key Menu Index

Frame and Table Lists

Symbol List

Technical Support

2. Installing a tape cartridge

⚠ CAUTION

- Make sure that the power is turned off.
- Be sure to use the specified tape cartridge.
- Make sure the top cover is closed firmly.
- If you opened the top cover while a tape cartridge is installed, check that the tape end is put into the tape eject slot before beginning operation.
- Take care to keep the label for detecting the tape cartridge and the sensor of the printer clean. Otherwise, tape may no longer be detected correctly.
- Do not touch the sensor directly with your fingers.

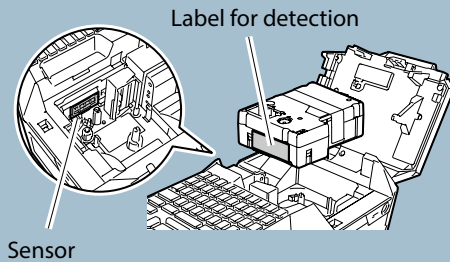

1. Rewind the ink ribbon if needed.

Use a pen or a pencil.

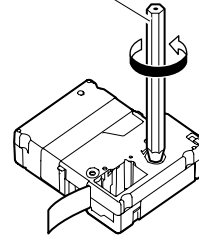

2. Open the top cover.

Top cover

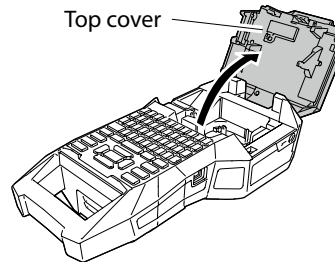

3. Install a tape cartridge.

Put the tape end into the tape eject slot.

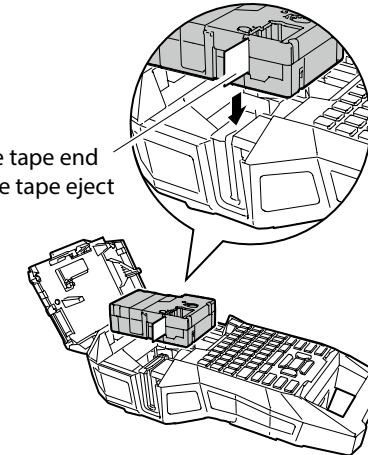

4. Close the top cover.

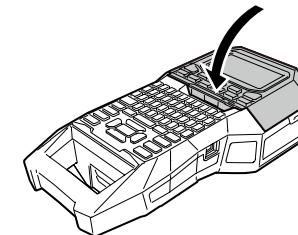

Top

Specifications

Using the printer with Easy-Mark Plus

Troubleshooting

Part Names and Functions

Start Here

Cleaning

Initializing the Settings

Label Functions

Key Menu Index

Frame and Table Lists

Symbol List

Technical Support

3. Turning the power on

1. Press .

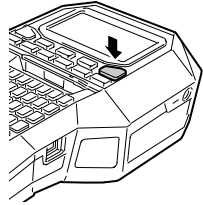





Auto power-off

If there is no key operation within five minutes, the printer automatically turns off. (The characters you have entered in the current session are stored.) Furthermore, if there is no key operation within an hour while connected to a computer, the printer automatically turns off.

■ Feeding the tape

CAUTION

Be sure to feed the tape every time after you install a tape cartridge.

1. Press .
 2. Select a function with / and then press .
- Tape feed**
Feeds the tape.
- Feed and cut**
Feeds the tape and then cuts the tape.

Top

Specifications

Using the printer with
Easy-Mark Plus

Troubleshooting

Part Names and
Functions

Start Here

Cleaning

Initializing the
Settings

Label Functions

Key Menu Index

Frame and Table Lists

Symbol List

Technical Support

4. Entering text

Ex Câble#101

1. Press .

  |

2. Press .

3. Press .

4. Press .

A list of characters appears.

For the accent marks that can be inserted  "Accent"

a
 àáâãäåæçàã
 â
 ä

5. Select a character with  /  and press .

"â" is entered.

  Câ |

6. Press keys: , , .

"Câble" appears on the screen.

7. Press  + .

"#" is entered.

8. Press keys: , , .

  Câble#101 |

Save the created label:  "Saving Frequently Used Labels"

Change the font size:  "Changing the Font Size"

■ Deleting text

1. Press .

A character is backspaced.

Deleting all text

1. Press  + .

2. Select a function with  /  and then press .

Text Only

Deletes all text.

Text & Setting

Deletes all text and restores the font size and other settings to the initial settings.

Top

Specifications

Using the printer with
Easy-Mark Plus

Troubleshooting

Part Names and
Functions

Start Here

Cleaning

Initializing the
Settings

Label Functions

Key Menu Index

Frame and Table Lists

Symbol List

Technical Support

5. Printing label

1. Press .

Setting the label auto cut to Off

 "Auto cut"

Printing with special print functions

 "Enlarge print"

■ Checking the print image +

1. Press  + .

The print image scrolls on the entire screen.
When the preview ends, the editing screen reappears.

CAUTION

- Do not insert your fingers into the tape eject slot.
- Do not pull the tape until the printing is completed.

Attention

- "Insert tape" will appear on the display if the tape cartridge is not loaded or not correctly set.
- Length of the label shown on the display is a guide and may not match the length of the printed label exactly.

MEMO

- To cancel the printing, press .
- Depending on your margin setting or the label type, tape may be fed and cut before printing.

Top

Specifications

Using the printer with
Easy-Mark Plus

Troubleshooting

Part Names and
Functions**Start Here**

Cleaning

Initializing the
Settings

Label Functions

Key Menu Index

Frame and Table Lists

Symbol List

Technical Support

6. Attaching label

1. Peel off the backing paper.



2. Attach the label and rub it firmly.



CAUTION

Depending on the environment where you use labels and the nature of the adhered surface, the labels may be peeled or discolored, and the adhesive may remain on or damage the adhered surface. Be sure to check the environment and the nature of the adhered surface before use. Panduit Corp. takes no responsibility for any damage or loss due to the above mentioned causes.

7. Turning the power off

1. Press .

The characters you have entered in the current session are stored even after the printer is turned off. They are displayed when it is turned on again.

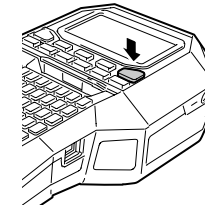

2. Open the battery cover and then remove the Li-ion battery.

If the AC adapter is connected, disconnect the AC adapter from the printer.

CAUTION

- "Powering off." is displayed while turning off this printer. Do not remove the Li-ion battery or disconnect the AC adapter until this message disappears.
- If you are not going to use the printer for a long period of time, remove the batteries (Li-ion battery or alkaline batteries), disconnect the AC adapter, and remove the tape cartridge from the printer.

Top

Specifications

Using the printer with
Easy-Mark Plus

Troubleshooting

Part Names and
Functions

Start Here

Cleaning

Initializing the
Settings

Label Functions

Key Menu Index

Frame and Table Lists

Symbol List

Technical Support

Cleaning

⚠ CAUTION

Turn off the printer and remove the batteries before cleaning. If the AC adapter is connected, disconnect the AC adapter cable from the printer.

Exterior

Wipe the dirt off with a soft cloth. If it is very dirty, use a damp cloth.

⚠ CAUTION

Never use chemicals or solvents such as benzene, thinner, or alcohol, or use a chemical duster.

Printhead

Clean the printhead with a cotton swab.

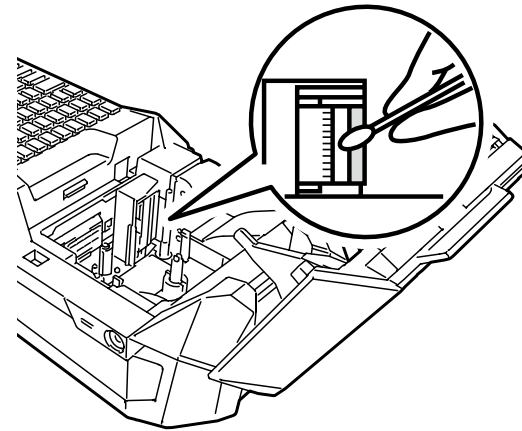

Top

Specifications

Using the printer with
Easy-Mark Plus

Troubleshooting

Part Names and
Functions

Start Here

Cleaning

Initializing the
Settings

Label Functions

Key Menu Index

Frame and Table Lists

Symbol List





Technical Support

Initializing the Settings

Initialize the settings if the printer does not operate normally such as when the display is interrupted.

Attention

This function initializes the settings. Take extreme care before initializing it. All the created text will be lost and the settings you made will be reset.

1. If the power is on, press  to turn it off.
2. Press and hold  + , and press .
3. When a message appears, press .
The settings will be initialized.

MEMO

To cancel initialization, press a key other than .

Top

Specifications

Using the printer with
Easy-Mark Plus

Troubleshooting

Part Names and
Functions

Start Here

Cleaning

**Initializing the
Settings**

Label Functions

Key Menu Index

Frame and Table Lists

Symbol List

Technical Support

Label Functions

Click the illustration of the label you wish to create, or function you wish to use, to display information such as the creation procedure or setting procedure.

Label Modes

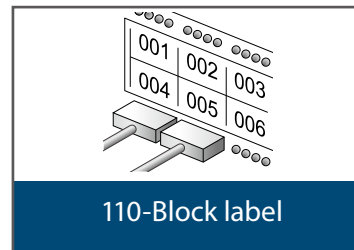
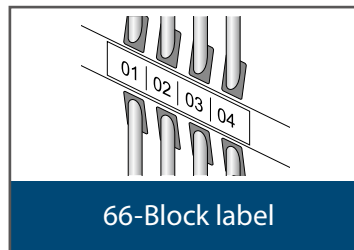
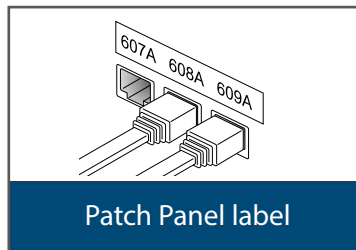
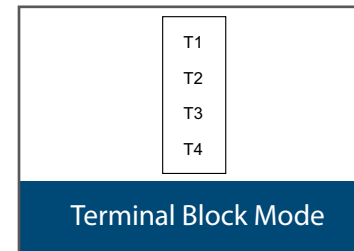
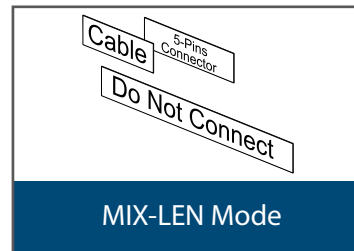
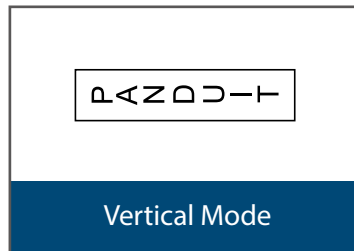
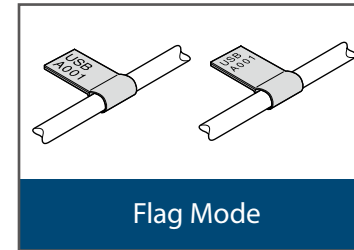
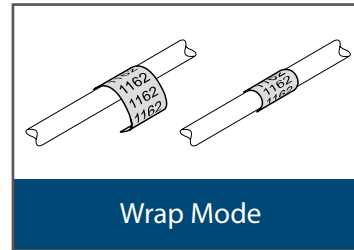
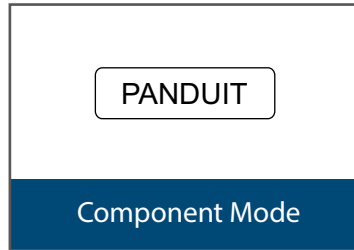
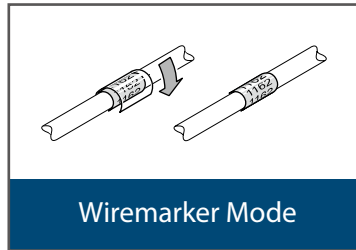

Top

Specifications

Using the printer with Easy-Mark Plus

Troubleshooting

Part Names and Functions

Start Here

Cleaning

Initializing the Settings

Label Functions

Key Menu Index

Frame and Table Lists

Symbol List

Technical Support

Customizing Labels

Label Functions

Swapping the Text

Barcode label

Label with symbol

Serialized labels

Advanced serialized labels

Format/Style

Font size

Text orientation

Length

Margins

Adding page

Specifying the Font Size

Large label

Mirrored text label

Printing Same Label Multiple Times

- Top
- Specifications
- Using the printer with Easy-Mark Plus
- Troubleshooting
- Part Names and Functions
- Start Here
- Cleaning
- Initializing the Settings
- Label Functions**
- Key Menu Index
- Frame and Table Lists
- Symbol List
- Technical Support

Useful Functions

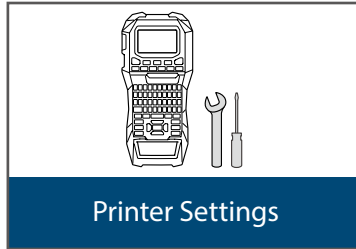
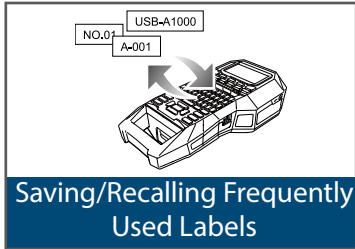

Label Functions

- Top
- Specifications
- Using the printer with Easy-Mark Plus
- Troubleshooting
- Part Names and Functions
- Start Here
- Cleaning
- Initializing the Settings
- Label Functions**
- Key Menu Index
- Frame and Table Lists
- Symbol List
- Technical Support

Wiremarker Mode

Create one label with the same text repeated



You can repeatedly print text so that it can be seen regardless of the angle from which the cable is viewed.

1. Press .

2. Enter the text and set the font size, layout, etc.

MEMO

- Add a column to continue creating another label with a set of text repeatedly printed on it.
- The amount of text that can be printed on a label varies according to the font size, number of lines, etc. set for the text.
- When the text orientation is set to Vert.2, the screen to set the length of the label may appear.

Top

Specifications

Using the printer with
Easy-Mark Plus

Troubleshooting

Part Names and
Functions

Start Here

Cleaning

Initializing the
Settings

Label Functions

Key Menu Index

Frame and Table Lists

Symbol List

Technical Support

Creating Labels with continuous self-lam Tape

■ Self-Lamination Overwrap

Use the dedicated Self-Lamination Overwrap. This label tape comes with transparent film. The film can be wrapped around the label to prevent it from getting dirty.

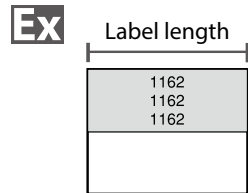
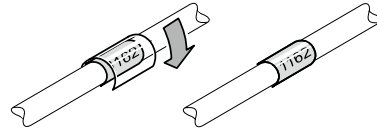

1. Enter the label length and then press .

Setting range: 0.39 to 39.36" (1 to 99.99 cm)

2. Enter the text.

3. Press .

Top

Specifications

Using the printer with
Easy-Mark Plus

Troubleshooting

Part Names and
Functions

Start Here

Cleaning

Initializing the
Settings**Label Functions**

Key Menu Index

Frame and Table Lists





Symbol List

Technical Support



Component Mode

Create die-cut tape labels of different settings at once +

You can create many die-cut labels at once.

1. Press  + .
2. Enter the text for the first label and press  + .
3. In a new block, enter the text for the second label.
Repeat these steps for all the labels you want to create.

MEMO

Entered text can be edited using , , etc.

Top

Specifications

Using the printer with
Easy-Mark Plus

Troubleshooting

Part Names and
Functions

Start Here

Cleaning

Initializing the
Settings

Label Functions

Key Menu Index

Frame and Table Lists

Symbol List

Technical Support

Wrap Mode

Creating Labels to Wrap around Cable

FLAG WRAP

You can repeatedly print text so that it can be seen regardless of the angle from which the cable is viewed.

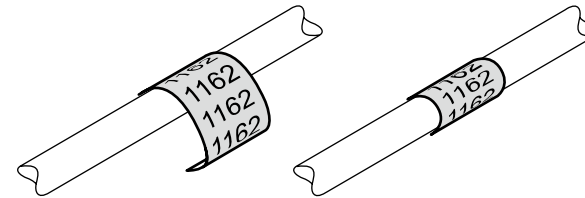
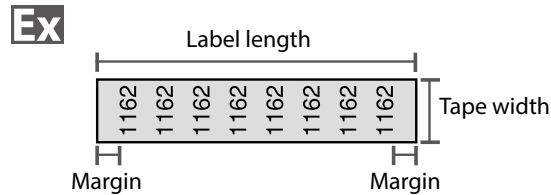

1. Press .
2. Select the length type with / and then press .
In this example, we will select "Length".
AWG: Sets the length according to the AWG wire size standards.
Dia: Sets the length by cable diameter.
(Setting range: 0.1 to 5.9" (0.25 to 15.00 cm))
Length: Sets the length by label length.
3. Enter the label length and then press .
Setting range: 0.39 to 39.36" (1 to 99.99 cm)

4. Select On or Off of repeat text with / and then press .

In this example, we will select "On".

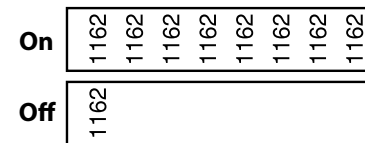

5. Select the type of margins with / and then press .

In this example, we will select "Long".

Tape/3: Sets margins that are 1/3 of the tape width.
Tape: Sets margins that are equal to the tape width.

6. Enter the text.
7. Press .

Top

Specifications

Using the printer with
Easy-Mark Plus

Troubleshooting

Part Names and
Functions

Start Here

Cleaning

Initializing the
Settings

Label Functions

Key Menu Index

Frame and Table Lists

Symbol List

Technical Support

Flag Mode

Creating Labels to Wrap around Cable like a Flag

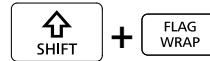

This label is useful for differentiating cables because the flag portion of the label wrapped around the cable is easy to see.

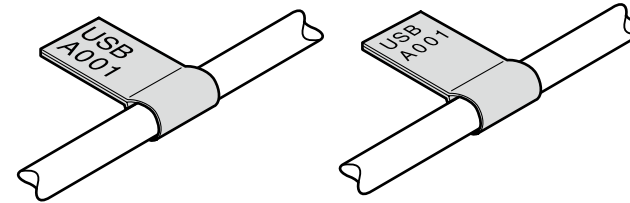
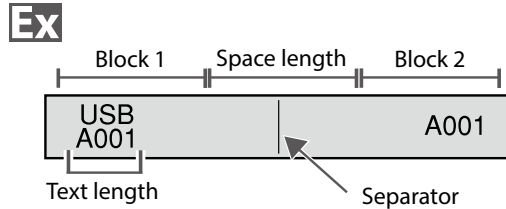

1. Press + .

2. Select the setting method of space length with / and then press .

In this example, we will select "Length".

AWG: Sets the length according to the AWG wire size standards.

Dia: Sets the length by cable diameter.
(Setting range: 0.1 to 5.91" (0.25 to 15.00 cm))

Length: Sets the length by space length.

3. Enter the space length and then press .

Setting range: 0.1 to 11.81" (0.25 to 30.00 cm)

4. Enter the text length and then press .

Setting range: 0.1 to 11.81" (0.25 to 30.00 cm)

5. Select the type of separator with / and then press .

In this example, we will select "Line".

6. Select the orientation with / and then press .

In this example, we will select "Hori.2".

Hori.1	USB A001	USB A001
Hori.2	USB A001	A001
Vert.1	USB A001	USB A001
Vert.2	USB A001	A001
Vert.3	USB A001	USB A001
Vert.4	USB A001	A001

7. Enter the text of block 1 and then press .

8. Enter the text of block 2.

9. Press .

Top

Specifications

Using the printer with
Easy-Mark Plus

Troubleshooting

Part Names and
Functions

Start Here

Cleaning

Initializing the
Settings

Label Functions

Key Menu Index

Frame and Table Lists

Symbol List



Technical Support

Tape Mode

Creating Labels with Text in the Horizontal

Orientation

Print labels with text in the horizontal orientation.

1. Press .
2. Enter the text.
3. Press .

Top

Specifications

Using the printer with
Easy-Mark Plus

Troubleshooting

Part Names and
Functions

Start Here

Cleaning

Initializing the
Settings

Label Functions

Key Menu Index

Frame and Table Lists

Symbol List



Technical Support

Vertical Mode

Creating Labels with Text in the Vertical

Orientation  + 

Print labels with text in the vertical orientation.

1. Press  + .
2. Enter the text.
3. Press .

Top

Specifications

Using the printer with
Easy-Mark Plus

Troubleshooting

Part Names and
Functions

Start Here

Cleaning

Initializing the
Settings

Label Functions

Key Menu Index

Frame and Table Lists

Symbol List

Technical Support

MIX-LEN Mode

Creating Multiple Labels at Once TERMINAL BLOCK MIX-LEN

You can create many mixed length labels at once.

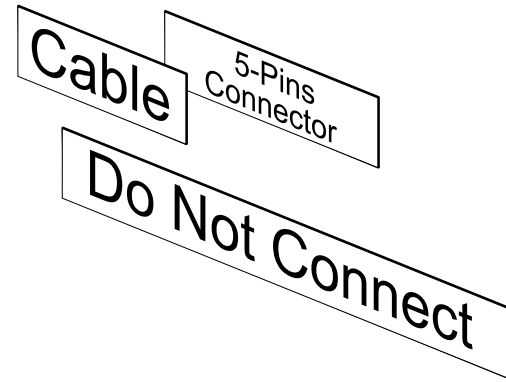
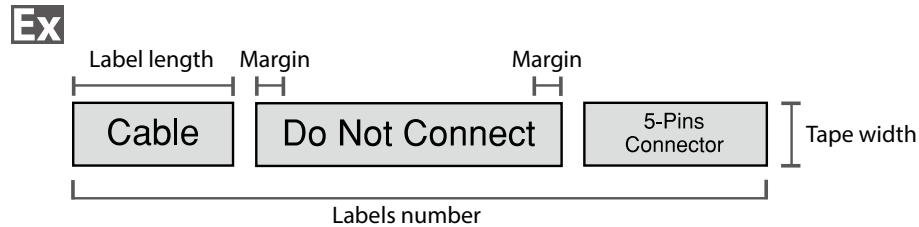

1. Press TERMINAL BLOCK MIX-LEN.
2. Select the label length with ▲/▼ and then press ENTER.
Auto: Automatically adjusts the label length depending on the length of text.
Set: Sets the label length.
Setting range: 0.39 to 39.36" (1 to 99.99 cm)
3. Enter the labels number and then press ENTER.
In this example, we will enter "3".

4. Select the type of margins with ◀/▶ and then press ENTER.
Tape/3: Sets margins that are 1/3 of the tape width.
Tape: Sets margins that are equal to the tape width.
5. Select the orientation with ▲/▼ and then press ENTER.
In this example, we will select "Hori".
Hori. 012
Vert.1 012
Vert.2 012
6. Enter "Cable" and then press PRINT/PREVIEW PAGE.
Similarly for other labels, enter text and press PRINT/PREVIEW PAGE.
7. Press PRINT.

Top

Specifications

Using the printer with Easy-Mark Plus

Troubleshooting

Part Names and Functions

Start Here

Cleaning

Initializing the Settings

Label Functions

Key Menu Index

Frame and Table Lists

Symbol List

Technical Support

Terminal Block Mode

Creating Labels for Terminal Block

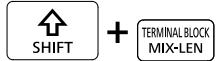

You can create labels optimized for terminal blocks by setting the pitch length and label length.

1. Press + .
2. Select the length type and then press .
In this example, we will select "Pitch".
Pitch: Sets the length by pitch length.
Label: Sets the length by label length.
3. Enter the pitch length and then press .
4. Enter the terminal number and then press .
In this example, we will enter "03".
5. Select the type of separator with / and then press .
In this example, we will select "Line".
6. Select the orientation with / and then press .
In this example, we will select "Vert.2".

Hori.	607A	608A	609A
Vert.1	607A	608A	609A
Vert.2	607A	608A	609A
7. Enter the text.
8. Press .

Top

Specifications

Using the printer with
Easy-Mark Plus

Troubleshooting

Part Names and
Functions

Start Here

Cleaning

Initializing the
Settings

Label Functions

Key Menu Index

Frame and Table Lists

Symbol List









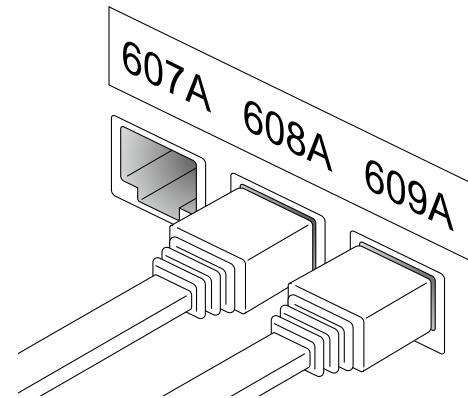
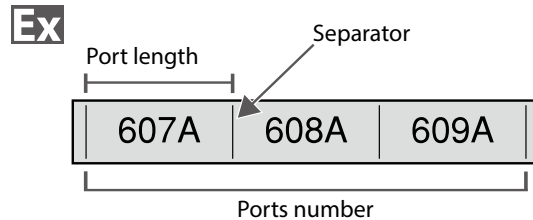



Technical Support

Network Mode

Creating Labels for Patch Panel

You can create the optimal labels for your patch panel by setting the label length and number of ports.





1. Press .
2. Select "P.Pan/F.Plake" with / and then press .
3. Select the length type with / and then press .
In this example, we will select "Ports".
Ports: Sets the length by port length.
Label: Sets the length by label length.
4. Enter the port length and then press .
Setting range: 0.1 to 11.81" (0.25 to 30.00 cm)
5. Enter the ports number and then press .
In this example, we will enter "3".
Setting range: 1 to 50
6. Select the type of separator with / and then press .
In this example, we will select "Line".

7. Select the orientation with / and then press .

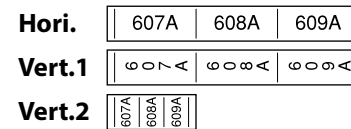
In this example, we will select "Hori."



8. Enter the text.
You can create labels with sequence numbers.
For details,  "Creating Labels with Advanced Serialization"
9. Press .

Top

Specifications

Using the printer with
Easy-Mark Plus

Troubleshooting

Part Names and
Functions

Start Here

Cleaning

Initializing the
Settings

Label Functions

Key Menu Index

Frame and Table Lists

Symbol List

Technical Support

Creating Labels for 66-Block NETWORK

You can create labels for 66-Block so that large numbers of connectors can easily be identified.

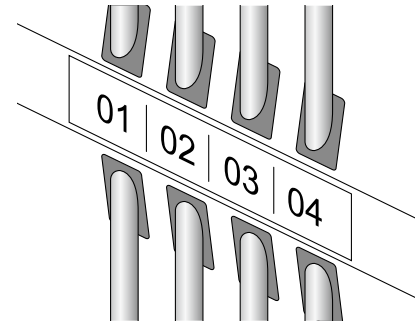
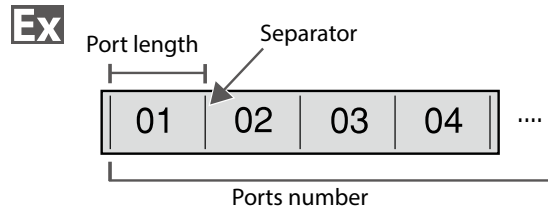

1. Press NETWORK.
2. Select "66-Block" with ▲/▼ and then press ENTER.
3. Select the length type with ▲/▼ and then press ENTER.
In this example, we will select "Ports".
Ports: Sets the length by port length.
Label: Sets the length by label length.
4. Enter the port length and then press ENTER.
Setting range: 0.1 to 11.81" (0.25 to 30.00 cm)
5. Enter the ports number and then press ENTER.
In this example, we will enter "4".
Setting range: 1 to 50
6. Select the type of separator with ▲/▼ and then press ENTER.
In this example, we will select "Line".

7. Select the orientation with ▲/▼ and then press ENTER.
In this example, we will select "Hori."

Hori.	607A	608A	609A
Vert.1	607A	608A	609A
Vert.2	607A	608A	609A
8. Enter the text.
You can create labels with sequence numbers.
For details, see "Creating Labels with Advanced Serialization"
9. Press PRINT.

Top

Specifications

Using the printer with Easy-Mark Plus

Troubleshooting

Part Names and Functions

Start Here

Cleaning

Initializing the Settings

Label Functions

Key Menu Index

Frame and Table Lists

Symbol List

Technical Support

Creating Labels for 110-Block NETWORK

You can create labels to identify at a glance the numbers for the wires or pins connected to a 110-Block.

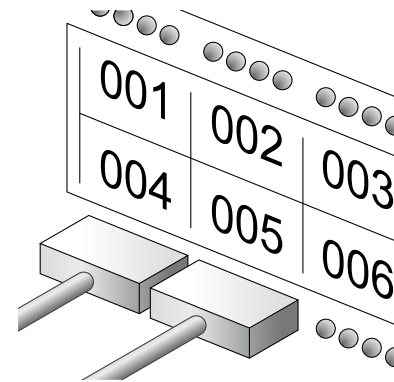
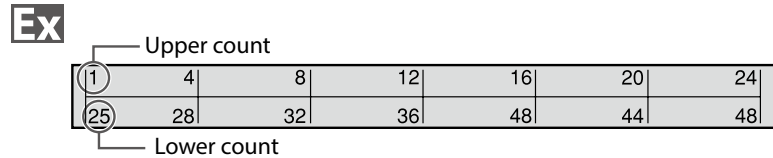

1. Press NETWORK.
2. Select "110-Block" with ▲/▼ and then press ENTER.
3. Select the blocks type with ▲/▼ and then press ENTER.

In this example, we will select "4pairs".

Blank: Creates a table of two rows and one column.

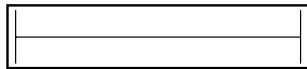

4. Select the text type with ▲/▼ and then press ENTER.

In this example, we will select "Pins".



5. Enter the upper count and then press ENTER.
In this example, we will enter "1".
6. Enter the lower count and then press ENTER.
In this example, "25" is entered automatically.
7. Enter the label length and then press ENTER.
Setting range: 0.39 to 39.36" (1 to 99.99 cm)
8. Press PRINT.

Top

Specifications

Using the printer with Easy-Mark Plus

Troubleshooting

Part Names and Functions

Start Here

Cleaning

Initializing the Settings

Label Functions

Key Menu Index

Frame and Table Lists

Symbol List

Technical Support

Customizing Labels

Swap the Order of Multiple Lines TEXT OPTIONS

Swaps the text line by line.



MEMO

You may not be able to swap the lines depending on the label type you create.

1. Press TEXT OPTIONS.
2. Select "Line swap" with ▲/▼ and press ENTER.
3. Select an area to which you want to apply the function with ▲/▼ and press ENTER.

Top

Specifications

Using the printer with
Easy-Mark Plus

Troubleshooting

Part Names and
Functions

Start Here

Cleaning

Initializing the
Settings

Label Functions

Key Menu Index

Frame and Table Lists

Symbol List

Technical Support

Creating Barcode Labels



MEMO

- You may not be able to add a barcode depending on the label type you create.
- Only up to two barcodes can be inserted in one label.

Supported barcode types:

EAN-8, EAN-13, CODE128, CODE39, QR CODE, ITF, CODABAR, UPC-A, UPC-E

1. Press .
2. Select an item with / and press .
Move on to the next options until the setting is complete.
3. Enter the alphanumeric characters for the barcode and then press .
4. Press .

Creating Labels with Symbols



1. Press .
2. Select a category with / and press .
3. Select a symbol with / and press .
4. Press .

MEMO

For available symbols "Symbol List"

Top

Specifications

Using the printer with Easy-Mark Plus

Troubleshooting

Part Names and Functions

Start Here

Cleaning

Initializing the Settings

Label Functions

Key Menu Index

Frame and Table Lists

Symbol List

Technical Support

Creating Serialized Labels

ADV.
123 SERIAL

Up to four digits including numbers (0 to 9) and alphabet letters (a to z and A to Z) can be entered.

MEMO

Printing will not continue from the next sequential number even if is pressed again after printing has completed. Printing will start from the first label set in the number sequence.
To continue printing from the next sequential number, reset the start value of the first label to the next sequential number.

Ex

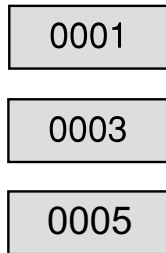

1. Press .
2. Enter the start value of the sequential numbers and then press .
In this example, we will enter "0001".
3. Enter the end value of the sequential numbers and then press .
In this example, we will enter "0005".
4. Enter the increment value and then press .
In this example, we will enter "2".
5. Press + .
One set of the set labels will be printed.

Creating Serialized Labels with Copies

1. Set the sequential numbers.
 "Creating Serialized Labels"
2. Press + .
3. Select "Print copies" with / and then press .
4. Enter the number of print copies and then press .
In this example, we will enter "2".
5. Select "Start print?" with / and then press .
Printing starts.

MEMO

When "Collate" under "Print copies" is set to "Yes", labels will be sorted and printed.
 "Creating Serialized Labels with Collate function"

Ex

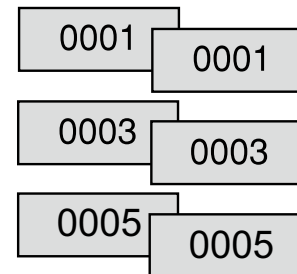

Top

Specifications

Using the printer with Easy-Mark Plus

Troubleshooting

Part Names and Functions

Start Here

Cleaning

Initializing the Settings

Label Functions

Key Menu Index

Frame and Table Lists

Symbol List

Technical Support

■ **Creating Serialized Labels with Collate function**

When printing serialized labels and using copies, the order of the labels can be changed. The default setting of the "Collate" function is "No".









Example: With the settings Start: 1, End: 3, Increment: 1, the labels will be printed in three sets.

Collate: No

1	1	1	2	2	2	3	3	3
---	---	---	---	---	---	---	---	---

Collate: Yes

1	2	3	1	2	3	1	2	3
---	---	---	---	---	---	---	---	---

1. Press  + .
2. Select "Collate" with / and press .
3. Select "Yes" with / and press .

Top

Specifications

Using the printer with
Easy-Mark Plus

Troubleshooting

Part Names and
Functions

Start Here

Cleaning

Initializing the
Settings**Label Functions**

Key Menu Index

Frame and Table Lists

Symbol List

Technical Support

Creating Labels with Advanced Serialization

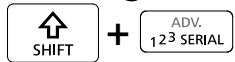

Use when creating a serialization across multiple pages in a label.

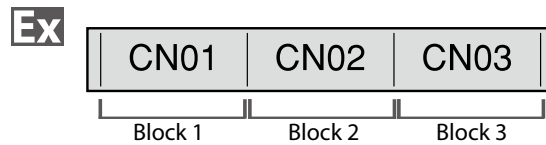

1. Create the blocks.

In this example, we have created three pages.
 "Adding Page"

2. Press + .

3. Enter the start value of the serialized numbers and then press .

In this example, we will enter "CN01".
 Serialized numbers are automatically assigned to block 2 and block 3.

4. Select the number of repetitions with / and then press .

In this example, we will select "1 time".

5. Press .

Top

Specifications

Using the printer with Easy-Mark Plus

Troubleshooting

Part Names and Functions

Start Here

Cleaning

Initializing the Settings

Label Functions

Key Menu Index

Frame and Table Lists

Symbol List

Technical Support

Setting the Format and Style (Text Options Menu)

Procedure for setting



1. Place the cursor.

Place the cursor on the left of the characters to which you want to apply a function.
If you want to apply the function to a specific line or block, confirm that the cursor is in the line or block.

2. Press .

Example: To apply "Bold & Italic"

3. Select "Bold & Italic" with / and press .

4. Select "B + I" with / and press .

5. Select an area to which you want to apply the function with / and press .

When "Character" is selected, the function is applied to all characters on the right of the cursor.

MEMO

The setting items displayed when you press  differ depending on the label type you create.

Text Options menu

You can customize your label by setting the following.

Layout

Left, Center, Justify, Right

Adjusts the layout when multiple lines are used.

Frame & Table

Decorates the text with a frame or inserts a table.

Style

Outline, Normal, Gray, Shadow, S+O

Applies a character style to text.

Char. spacing

None, Narrow, Normal, Wide

Sets the inter-character spacing.

Border & Line

Strikeout, Underline, None, Border, Round brdr

Applies border, underline etc. to text.

Char. Width

Smaller, Small, Narrow, Normal, Wide

This allows you to change the width or height of characters.

menu continues forward



Top

Specifications

Using the printer with Easy-Mark Plus

Troubleshooting

Part Names and Functions

Start Here

Cleaning

Initializing the Settings

Label Functions

Key Menu Index

Frame and Table Lists

Symbol List

Technical Support

Bold & Italic

Italic, Normal, Bold, B+I

Changes the text in bold or italics.

Length

This setting is the same as when  is pressed.

 "Setting the Label Length"

Margins

This setting is the same as when  is pressed.

 "Setting the Margins"

Orientation

|AB|A, |A B|, |AB|AB

Sets the orientation of the text.

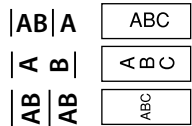

Font size

Select font size from preset patterns or from "Manual".

When "Manual" is selected, font size can be set for each block line by line.

 "Changing the Font Size"

 "Specifying the Font Size"

Line swap

Swaps the order of text line by line.

You may not be able to swap the lines depending on the label type you create.

 "Swap the Order of Multiple Lines"

menu
continues
backward



Top

Specifications

Using the printer with
Easy-Mark Plus

Troubleshooting

Part Names and
Functions

Start Here

Cleaning

Initializing the
Settings

Label Functions

Key Menu Index

Frame and Table Lists

Symbol List

Technical Support

Changing the Font Size FONT SIZE

The font size automatically adjusts to fit the text within the label area. As more text is entered within a fixed area, the text size will automatically decrease. If text is deleted, then the text size will automatically increase.

Changing the Font Size from preset options

Changing the Font Size for a Label with One Line of Text

Press FONT SIZE to select from the preset options. Pressing FONT SIZE multiple times will scroll through all options.

Changing the Font Size for a Label with More than One Line of Text

When pressing FONT SIZE, the screen will show the number of lines you have created and allow you to select from the preset options. Pressing FONT SIZE multiple times will scroll through all options.

Changing the Font Size Manually

To change the font size of a page, line by line, press TEXT OPTIONS. Then select "Font size", "7- Lines", "Manual".

This will allow you to set the font size for the each individual line.

 "Specifying the Font Size"

MEMO

- You may not be able to change the font size depending on the label type you create.
- If your text contains only the letters and/or marks described below, it is printed larger than text that contains the other letters and/or marks.

Numbers, English alphabet uppercase letters, space, and the following marks; ! " # % & ' * + - . / : < = > ? \ ^

Danger DANGER

1. Press FONT SIZE.
2. Each time you press FONT SIZE, the font size changes.

Top

Specifications

Using the printer with Easy-Mark Plus

Troubleshooting

Part Names and Functions

Start Here

Cleaning

Initializing the Settings

Label Functions

Key Menu Index

Frame and Table Lists

Symbol List

Technical Support

Changing the Text Orientation



Changes the text orientation to vertical or horizontal.

MEMO

You may not be able to change the text orientation depending on the label type you create.

1. Press + .

Each time you press + , the setting switches between "Horizontal" and "Vertical".

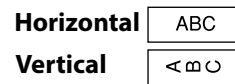

MEMO

The items that can be set vary depending on the label type you create.

Setting the Label Length



You can set the length of label or block.

MEMO

- This cannot be set for a die-cut label.
- When creating a special label, you can set the length again. Setting items for the special label is displayed after pressing .

1. Press .
2. Select the setting method of the length with / and press .

 - Auto:** Automatically adjusts the label length depending on the length of text.
 - Set:** Sets the label length. Setting range: 1.00 to 99.99 cm

3. Select the alignment for the text with / and press .

Left, Center, Justify, Right

Setting the Margins



Sets the left and right margins.

MEMO

You may not be able to set the margins depending on the label type you create.

1. Press .
2. Select the type of margins with / and press .

 - Tape width /3:** Sets margins that are 1/3 of the tape width.
 - Tape width:** Sets margins that are equal to the tape width.

- Top
- Specifications
- Using the printer with Easy-Mark Plus
- Troubleshooting
- Part Names and Functions
- Start Here
- Cleaning
- Initializing the Settings
- Label Functions**
- Key Menu Index
- Frame and Table Lists
- Symbol List
- Technical Support

Adding Page



By dividing text into blocks, you can change the style and the number of lines block-by-block.

Display

```
01 1 Cable
   2 #101
02 1 USB No.1
   2 USB No.2
```

Label

Cable	USB No.1
#101	USB No.2

Block 1 Block 2

1. Press .

A new block is started from the character next to the cursor.

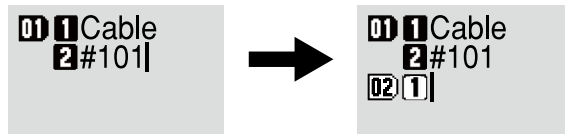

Specifying the Font Size



You can change the font size of a block/page line by line.

```
USB cable
Type A
#002
```

```
USB cable
Type A
#002
```

MEMO

- For Tape mode and Vertical mode, you can also change the font size through the text option menu.
- The font sizes that can be set will differ depending on the width of the tape in use or the number of lines of text.
- The font size of the text is automatically adjusted according to the width of the tape. So even if the first line is set to the largest font size, its size may be changed depending on the font size settings of the second and third lines.

There are two ways to adjust font size:

Through

1. Keep pressing the to select among preset font size patterns.

Through

1. Press .
2. Select "Font size" and press .
3. Select the number of lines with and press .
4. Select "Manual" with and press .
5. Select the line to be changed with and change the font size with .
6. When the settings are complete, press .

Top

Specifications

Using the printer with Easy-Mark Plus

Troubleshooting

Part Names and Functions

Start Here

Cleaning

Initializing the Settings

Label Functions

Key Menu Index

Frame and Table Lists

Symbol List

Technical Support

■ Enlarge print

You can create a label that is larger than the width of a single label.
Print the created content separately on multiple labels and then put them together to use as a single label.



1. Press + .
2. Select "Enlarge print" with / and press .
3. Select "*2size" with / and press .
4. Select "2/2" with / and press .
5. Select "Start print?" with / and press . Printing starts.

MEMO

The function remains enabled even after printing. To disable the function, select "Off".

■ Mirror print



1. Press + .
2. Select "Mirror print" with / and press .
3. Select "On" with / and press .
4. Select "Start print?" with / and press . Printing starts.

MEMO

The function remains enabled even after printing. To disable the function, select "Off".

■ Print copies



1. Press + .
2. Select "Print copies" with / and press .
3. Enter the number of print copies and then press .
4. Select "Start print?" with / and press . Printing starts.

MEMO

The function remains enabled even after printing. To disable the function, set the number of print copies to "1".

Top

Specifications

Using the printer with Easy-Mark Plus

Troubleshooting

Part Names and Functions

Start Here

Cleaning

Initializing the Settings

Label Functions

Key Menu Index

Frame and Table Lists

Symbol List

Technical Support

Saving Frequently Used Labels



By saving frequently used labels, you will be able to easily recall and print from them next time. Up to 100 labels can be saved.

■ Saving a label

1. Press
2. Select "Save" with / and press
3. Select a number that is available with / or the number keys and then press .
The screen to enter the file name appears.
4. Enter the file name and press .
The file name can contain up to 10 characters. The following characters can be used.
0 to 9, A to Z, a to z, space, ! @ # \$ % ^ & * () - = + [] { } ; : ' " , . < > / ? \ ` ~ | _
The registration confirmation screen appears.
5. Confirm the registration number and then press .

■ Recall the saved label

1. Press
2. Select "Recall" with / and press
3. Select a file name with / or the number keys and then press .
The recall confirmation screen appears.
4. Confirm the file name and then press .

MEMO

Information of the label, including information of the tape in use, is saved in the file. Therefore, if the specifications of the tape set in the printer differ with the tape information saved in the file you want to recall, such as the type of tape, etc., an error message will appear. Switch to a tape with specifications that match the information in the saved file.

■ Printing the saved label

You can select multiple files and print them at once.

1. Press
2. Select "Print" with / and press
3. Select a file name with / or the number keys and then press .
By continuously selecting registration numbers and pressing , you can select multiple files to print them together.
4. Select "Print Start" with / and press .
Printing starts.

MEMO

You can also select "Print Start" by pressing + /.

■ Deleting the saved label

1. Press
2. Select "Delete" with / and press
3. Select a file name with / or the number keys and then press .
The deletion confirmation screen appears.
4. Confirm the file name and then press .

Top

Specifications

Using the printer with Easy-Mark Plus

Troubleshooting

Part Names and Functions

Start Here

Cleaning

Initializing the Settings

Label Functions

Key Menu Index

Frame and Table Lists

Symbol List

Technical Support

Changing the Printer Settings



Auto cut

Auto cut:

Sets whether or not to cut automatically.

Half cut:

When "Auto cut" is set to "On", the "Half cut" function is available. "Half cut" will cut through just the label material, but not the liner material, to make the label easy to remove.

Print density

Sets the print density.

Print density can be adjusted to improve print quality, if needed.

Drop stop

This function will hold printed labels in place until they are removed. After being removed, the next label will begin printing automatically. This pause function stops the printed labels from dropping out of the printer and holds them for easy removal.

When printing multiple copies, printing of the second or later labels starts each time you remove a printed label. This function is only available when the label length is 1.1 inches (28 mm) or more, "Auto cut" is set to "On", and "Half cut" is set to "Off".

MEMO

If you perform continuous printing with the Drop stop function enabled, printing may not be automatically resumed after you take out the printed tape. In such a case, open and close the top cover and choose "Print restart".

Die-Cut pos

Adjusts the text position on a die-cut label.

Width pos: Adjusts the vertical positioning of text.

Length pos: Adjusts the horizontal positioning of text.

Backlight

Sets the display backlight to On or Off.

Language

You can select the language shown on the display from the following:

Dansk, Deutsch, English, Español, Français, Italiano, Nederlands, Norsk, Português-Br, Português-EU, Suomi, Svenska, Türkçe







inch/cm

The unit of length used to indicate the label size can be switched between inch and cm.

MEMO

Version: The printer firmware version number.

Procedure for setting

1. Press  .
2. Select the desired function with  /  and press  .
3. Select the desired item with  /  and press  .

Top

Specifications

Using the printer with Easy-Mark Plus

Troubleshooting

Part Names and Functions

Start Here

Cleaning

Initializing the Settings

Label Functions

Key Menu Index

Frame and Table Lists

Symbol List

Technical Support

Key Menu Index

Click the keys boxed in blue to display the menu list page.



Top

Specifications

Using the printer with
Easy-Mark Plus

Troubleshooting

Part Names and
Functions

Start Here

Cleaning

Initializing the
Settings

Label Functions

Key Menu Index

Frame and Table Lists

Symbol List

Technical Support

Feed and Cut

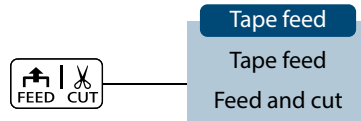

Multi print

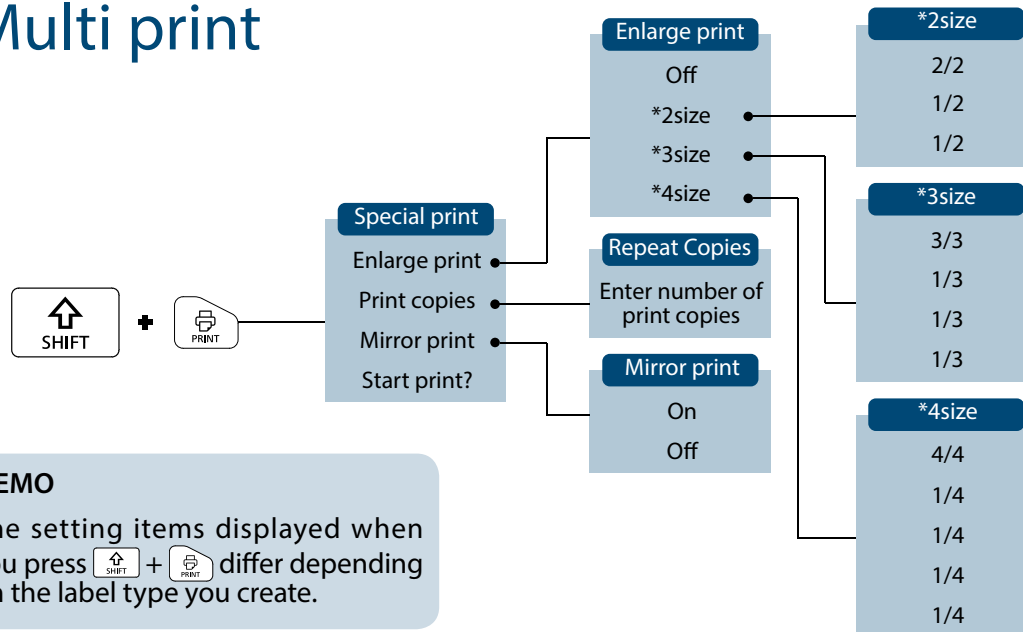

MEMO
 The setting items displayed when you press + differ depending on the label type you create.

- Top
- Specifications
- Using the printer with Easy-Mark Plus
- Troubleshooting
- Part Names and Functions
- Start Here
- Cleaning
- Initializing the Settings
- Label Functions
- Key Menu Index**
- Frame and Table Lists
- Symbol List
- Technical Support

Serialize



Advanced Serialize

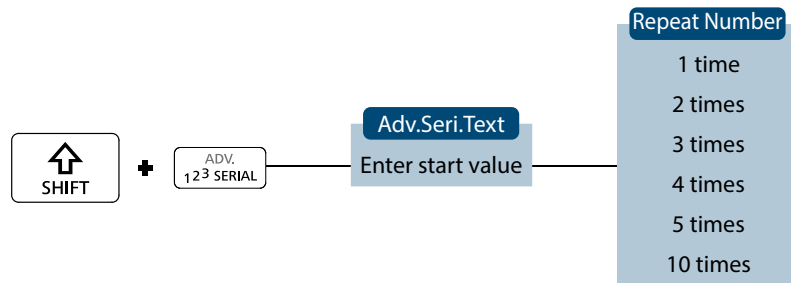

Top

Specifications

Using the printer with Easy-Mark Plus

Troubleshooting

Part Names and Functions

Start Here

Cleaning

Initializing the Settings

Label Functions

Key Menu Index

Frame and Table Lists

Symbol List

Technical Support

Barcode 1

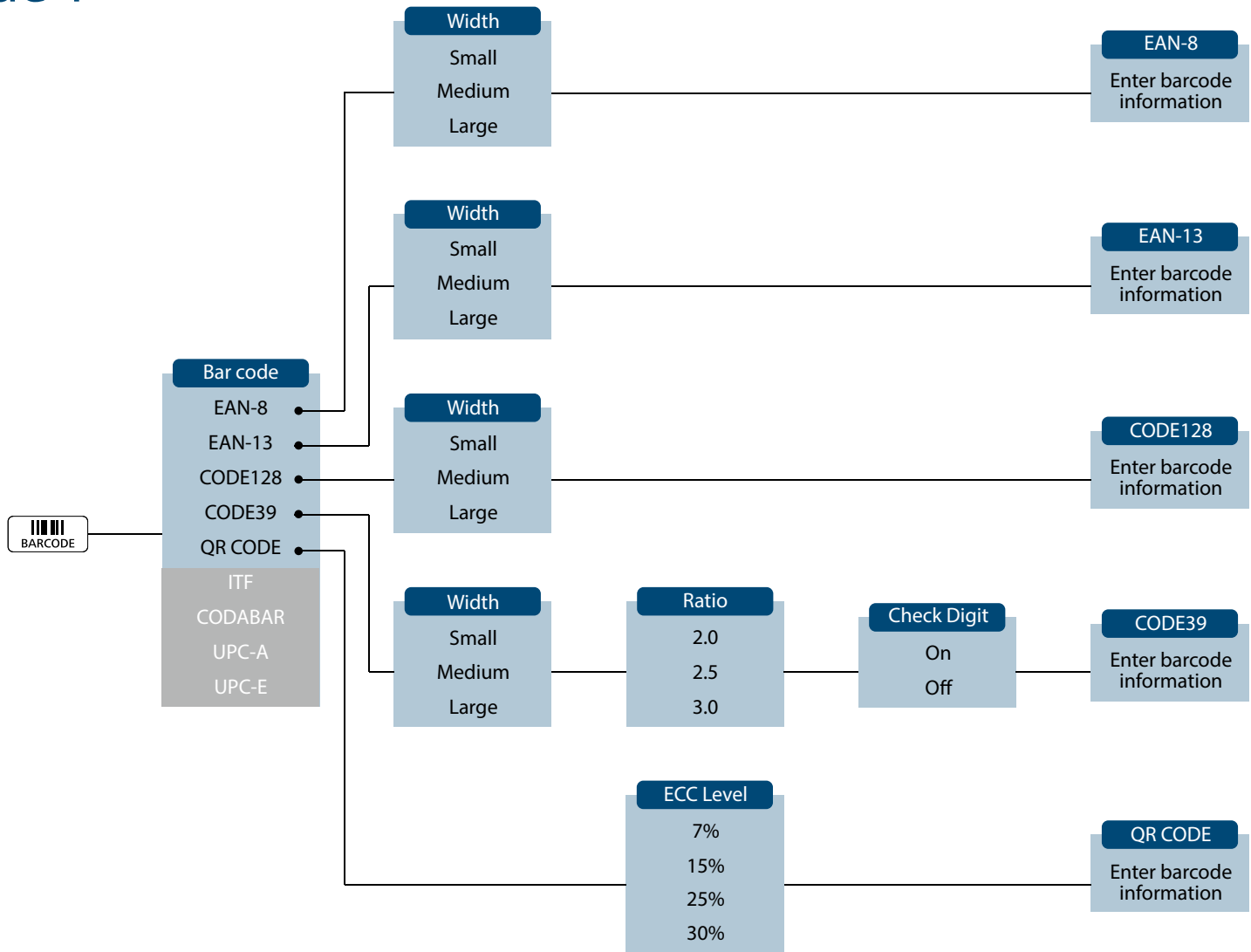

menu continues forward



- Top
- Specifications
- Using the printer with Easy-Mark Plus
- Troubleshooting
- Part Names and Functions
- Start Here
- Cleaning
- Initializing the Settings
- Label Functions
- Key Menu Index**
- Frame and Table Lists
- Symbol List
- Technical Support

Barcode 2

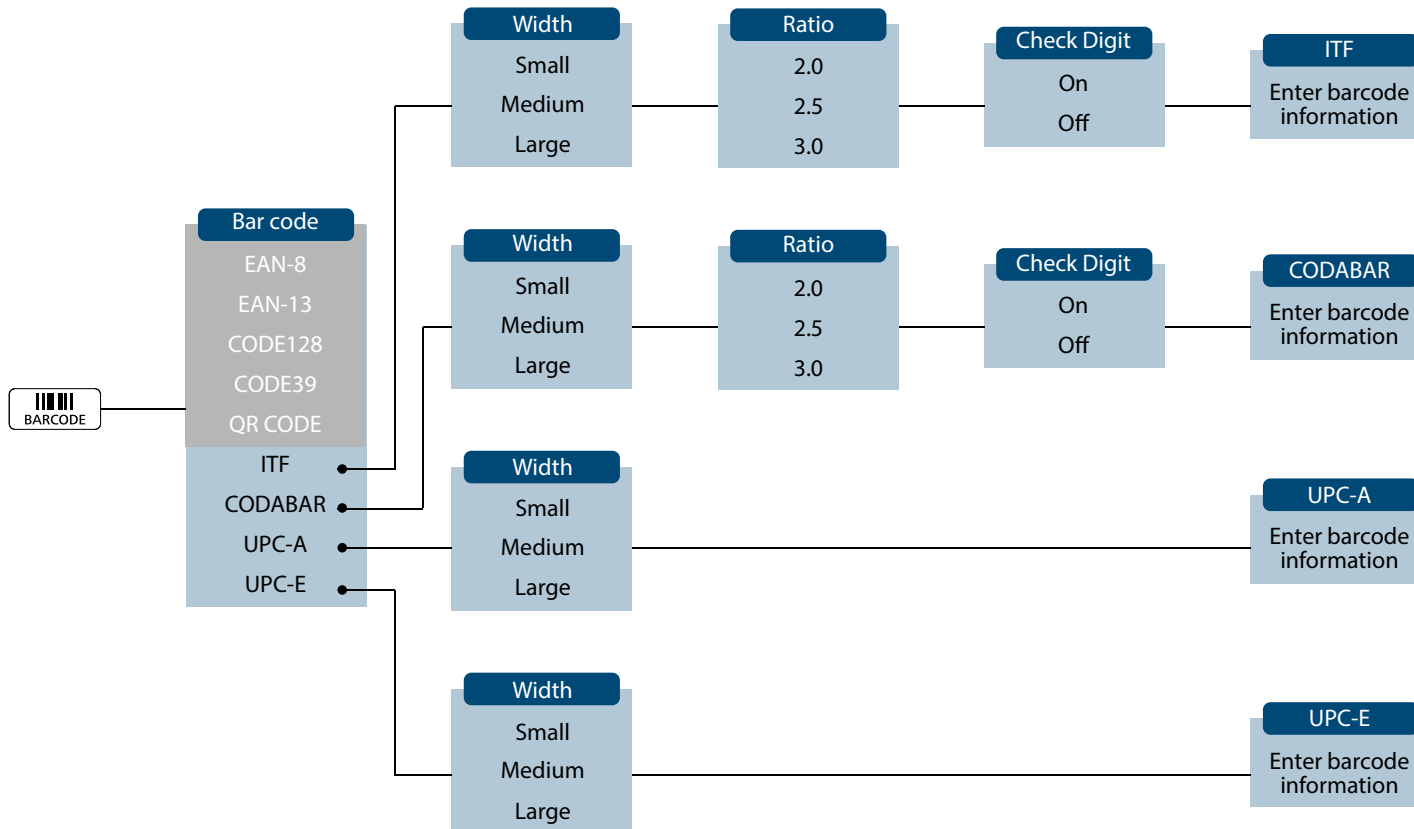

menu continues backward



- Top
- Specifications
- Using the printer with Easy-Mark Plus
- Troubleshooting
- Part Names and Functions
- Start Here
- Cleaning
- Initializing the Settings
- Label Functions
- Key Menu Index**
- Frame and Table Lists
- Symbol List
- Technical Support

Margins

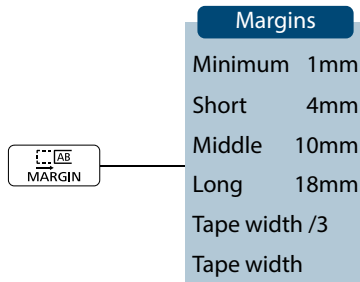

MEMO

The setting items displayed when you press  differ depending on the label type you create.

Length

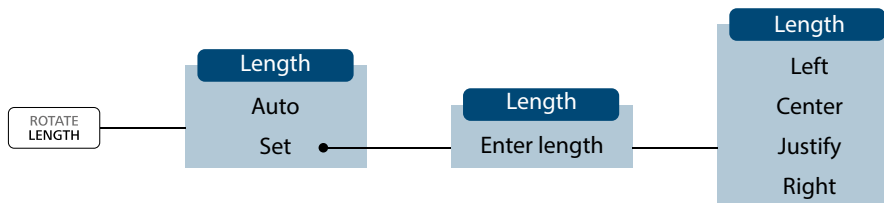

MEMO

The setting items displayed when you press  differ depending on the label type you create.

Top

Specifications

Using the printer with Easy-Mark Plus

Troubleshooting

Part Names and Functions

Start Here

Cleaning

Initializing the Settings

Label Functions

Key Menu Index

Frame and Table Lists

Symbol List

Technical Support

Text Options 1

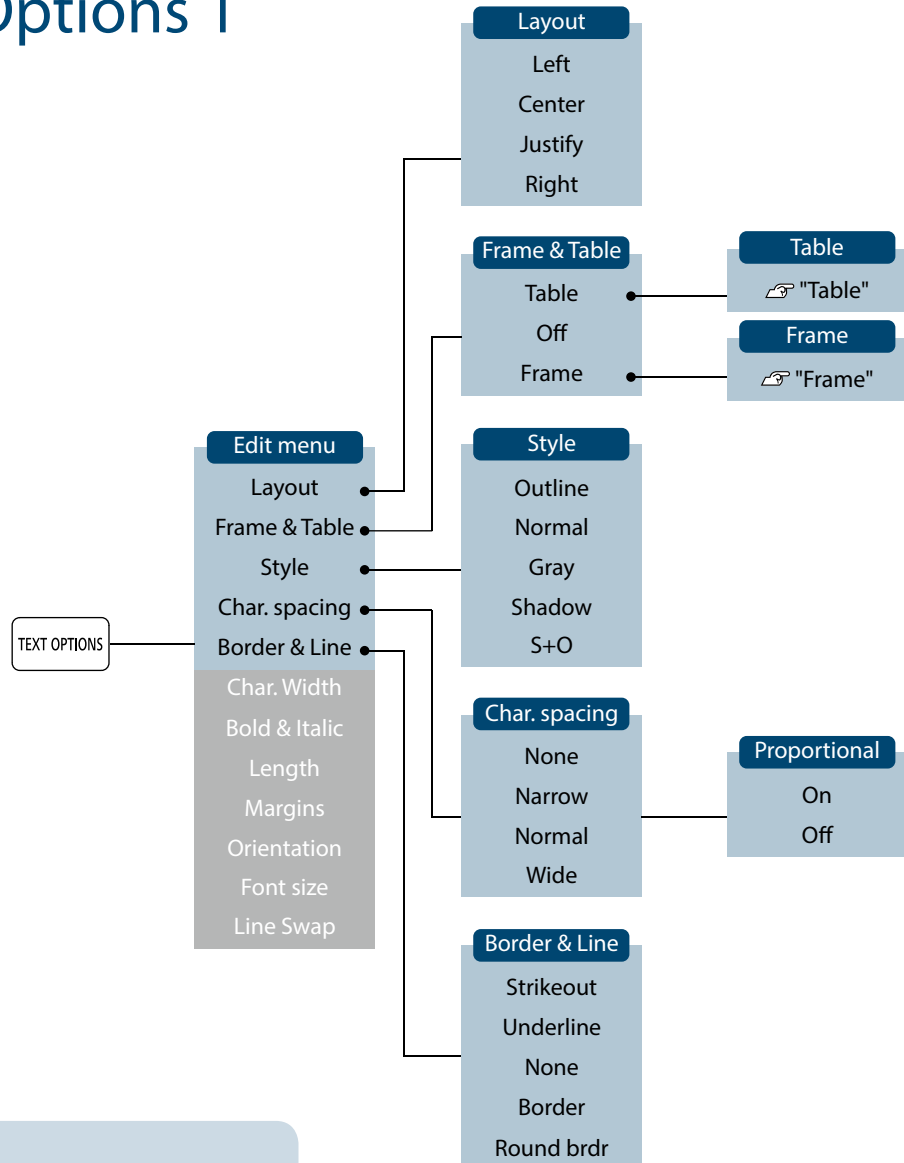

MEMO

The setting items displayed when you press  differ depending on the label type you create.

menu continues forward



Top

Specifications

Using the printer with Easy-Mark Plus

Troubleshooting

Part Names and Functions

Start Here

Cleaning

Initializing the Settings

Label Functions

Key Menu Index

Frame and Table Lists

Symbol List

Technical Support

Text Options 2

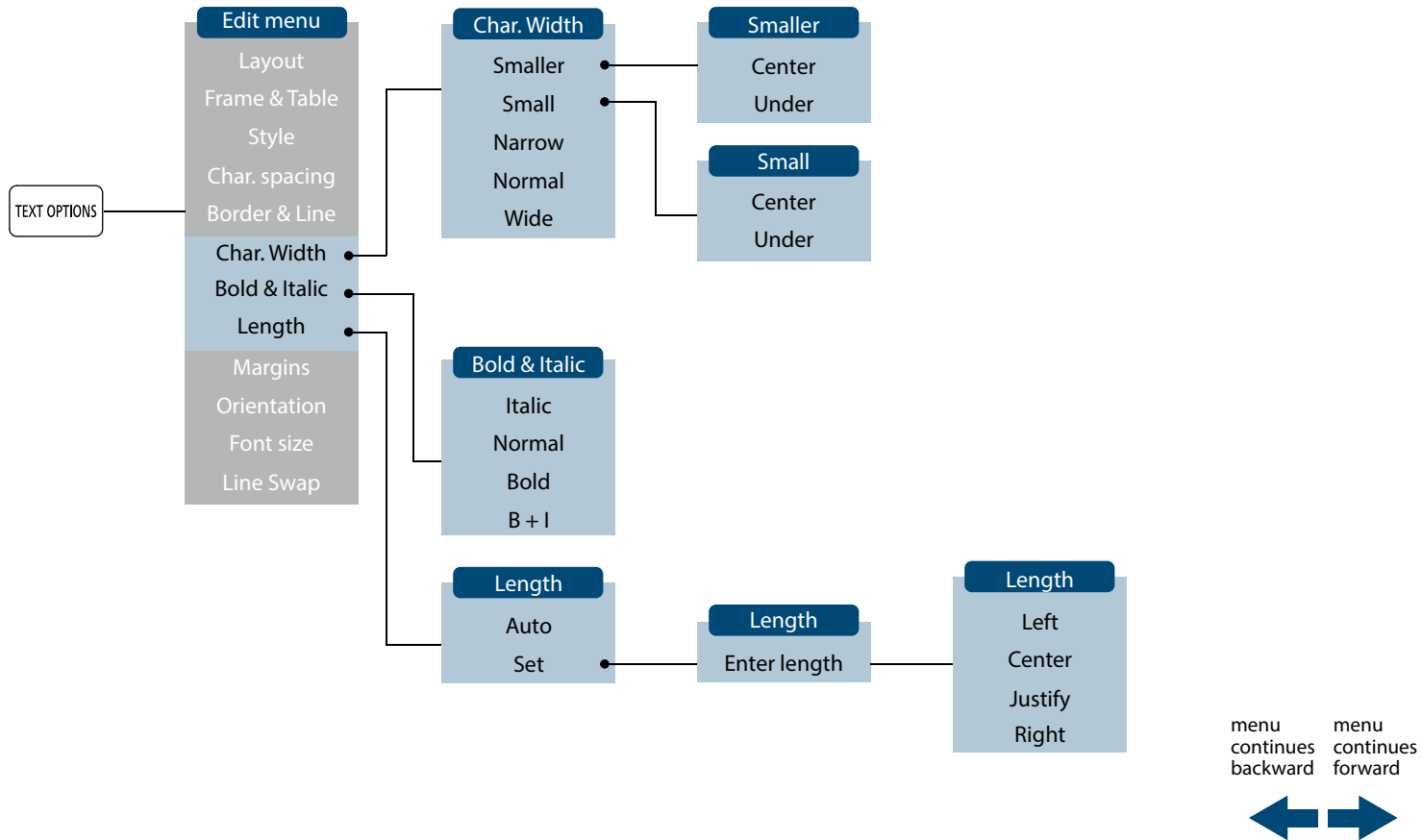

Top

Specifications

Using the printer with
Easy-Mark Plus

Troubleshooting

Part Names and
Functions

Start Here

Cleaning

Initializing the
Settings

Label Functions

Key Menu Index

Frame and Table Lists

Symbol List

Technical Support

Text Options 3

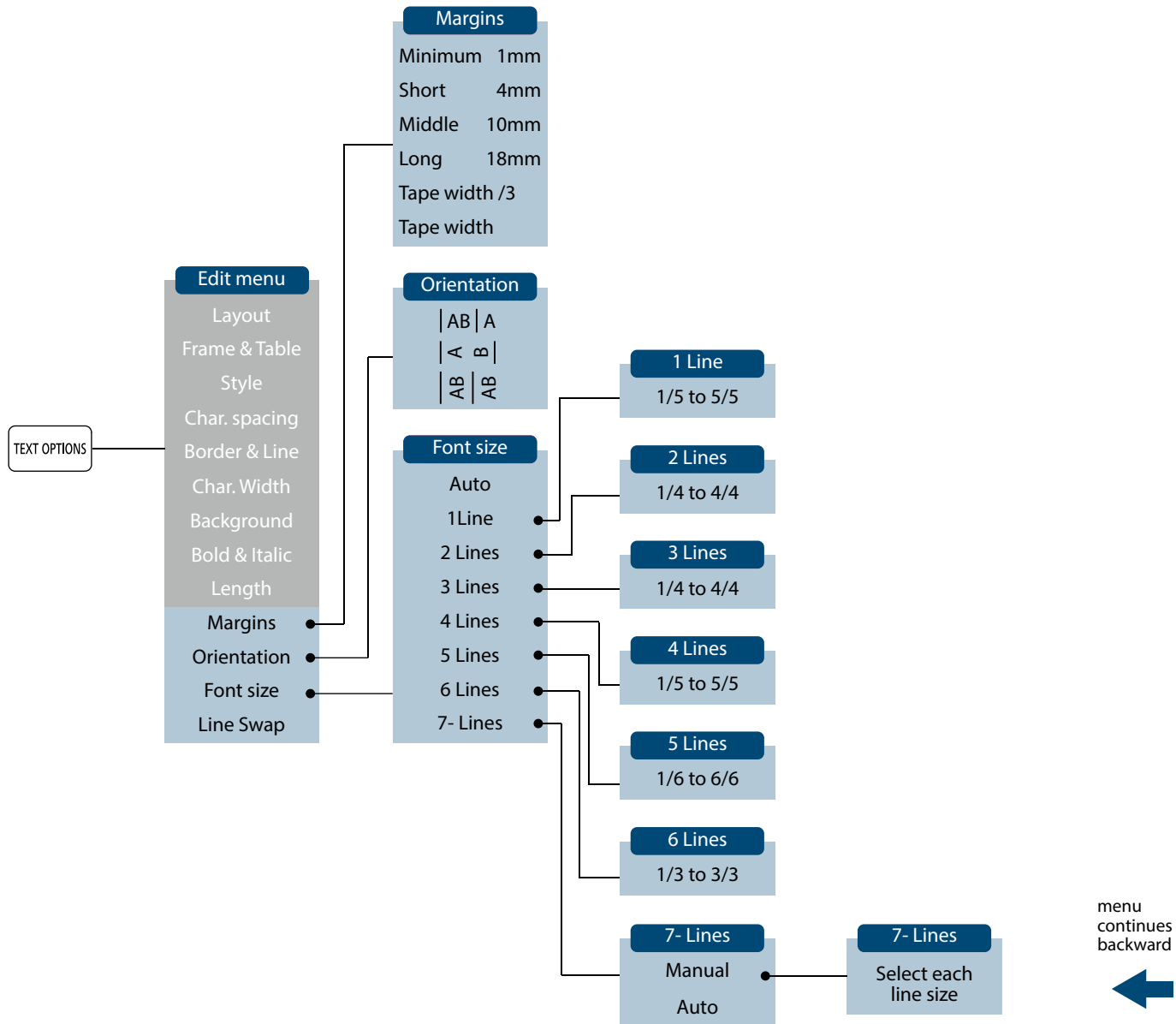

- Top
- Specifications
- Using the printer with Easy-Mark Plus
- Troubleshooting
- Part Names and Functions
- Start Here
- Cleaning
- Initializing the Settings
- Label Functions
- Key Menu Index**
- Frame and Table Lists
- Symbol List
- Technical Support

Wrap

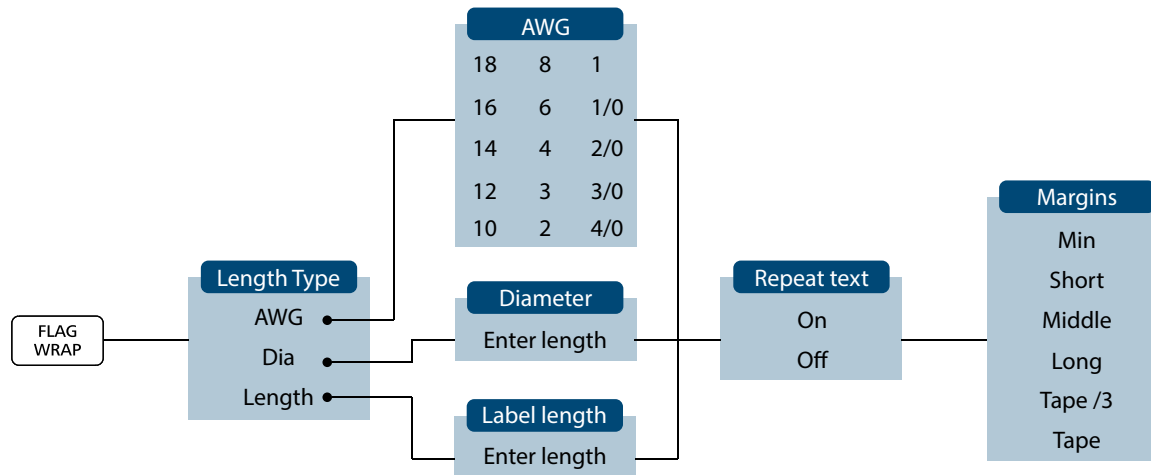

Flag

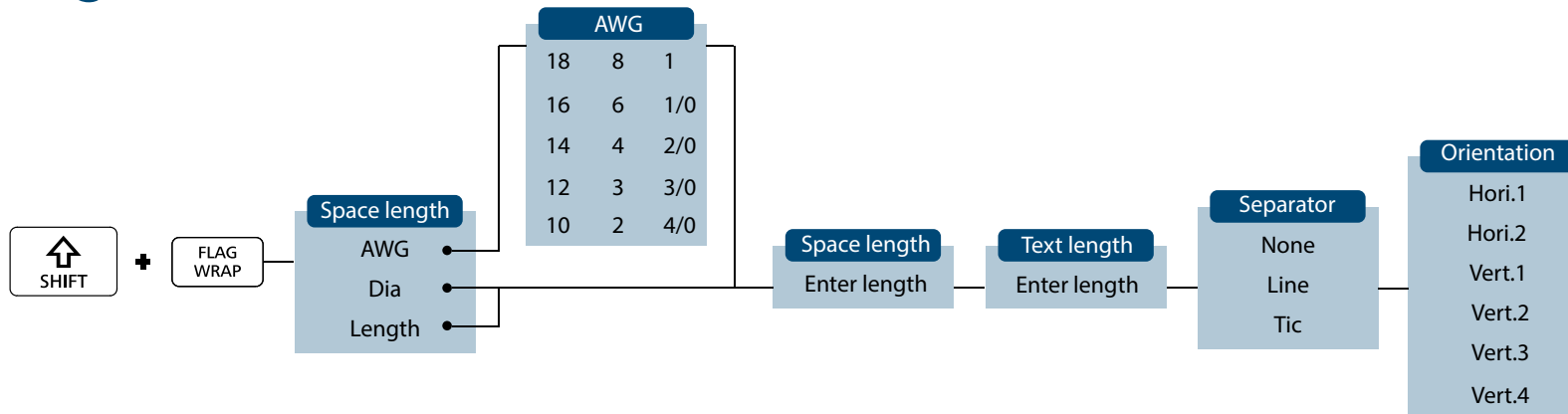

Top

Specifications

Using the printer with Easy-Mark Plus

Troubleshooting

Part Names and Functions

Start Here

Cleaning

Initializing the Settings

Label Functions

Key Menu Index

Frame and Table Lists

Symbol List

Technical Support

Mix-Len

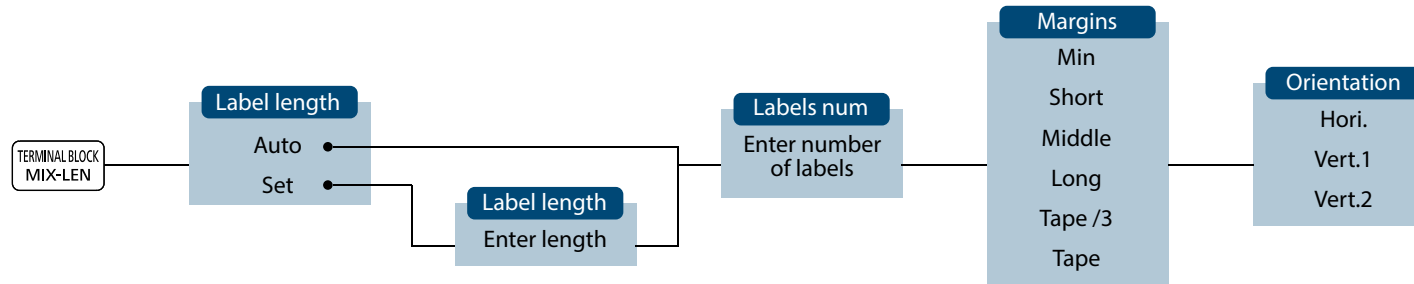

Terminal block

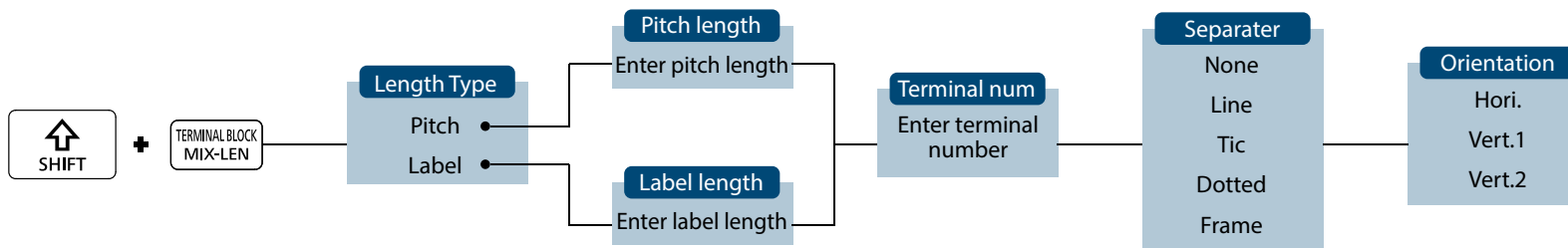

Top

Specifications

Using the printer with Easy-Mark Plus

Troubleshooting

Part Names and Functions

Start Here

Cleaning

Initializing the Settings

Label Functions

Key Menu Index

Frame and Table Lists

Symbol List

Technical Support

Patch Panel

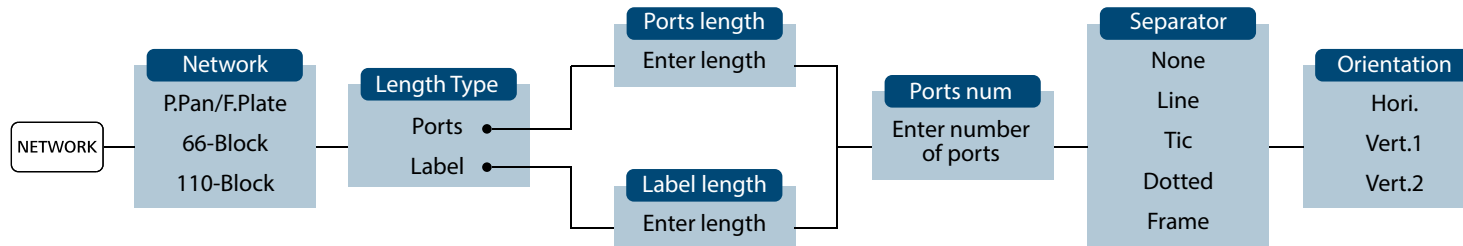

66-Block

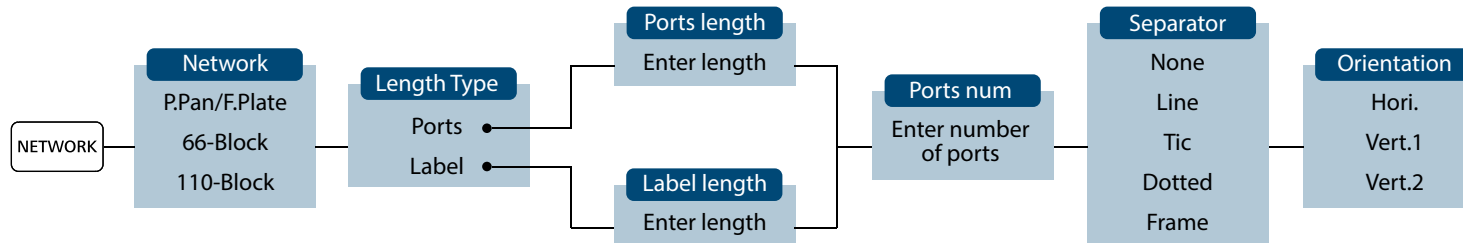

Top

Specifications

Using the printer with Easy-Mark Plus

Troubleshooting

Part Names and Functions

Start Here

Cleaning

Initializing the Settings

Label Functions

Key Menu Index

Frame and Table Lists

Symbol List

Technical Support

110-Block

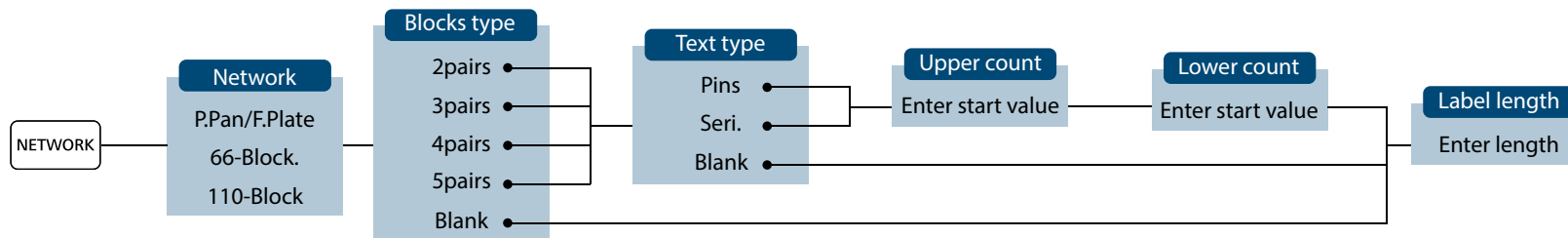

Top

Specifications

Using the printer with
Easy-Mark Plus

Troubleshooting

Part Names and
Functions

Start Here

Cleaning

Initializing the
Settings

Label Functions

Key Menu Index

Frame and Table Lists

Symbol List

Technical Support

Clear

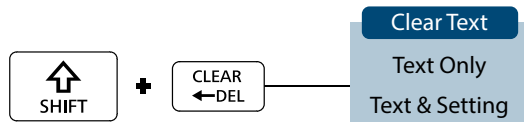

Top

Specifications

Using the printer with
Easy-Mark Plus

Troubleshooting

Part Names and
Functions

Start Here

Cleaning

Initializing the
Settings

Label Functions

Key Menu Index

Frame and Table Lists

Symbol List

Technical Support

Setup Menu 1

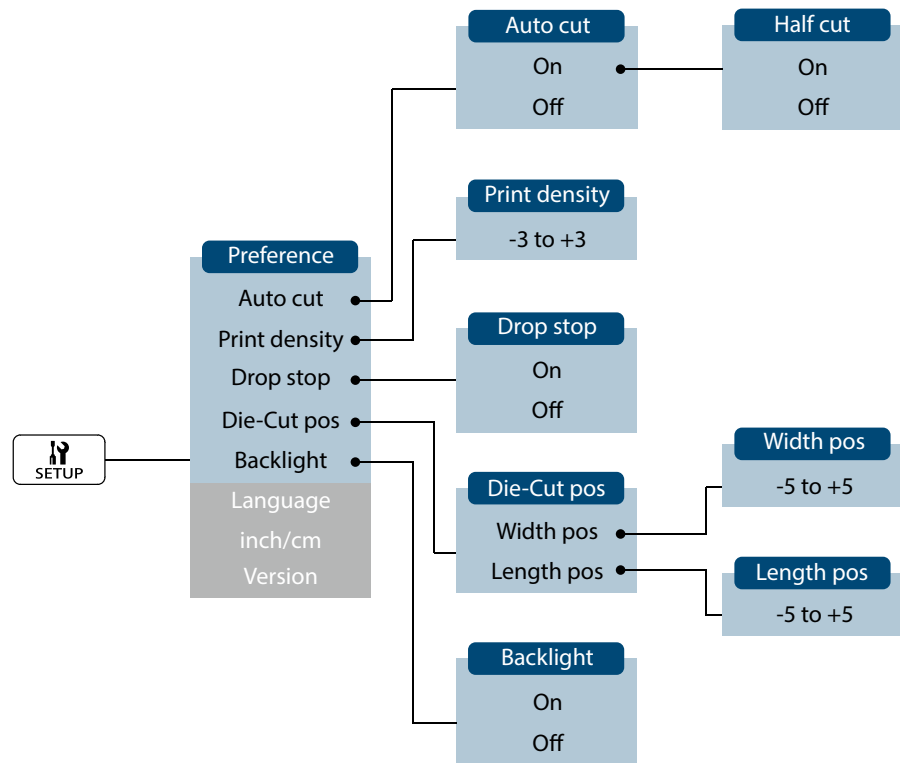

menu continues forward



Top

Specifications

Using the printer with Easy-Mark Plus

Troubleshooting

Part Names and Functions

Start Here

Cleaning

Initializing the Settings

Label Functions

Key Menu Index

Frame and Table Lists

Symbol List

Technical Support

Setup Menu 2

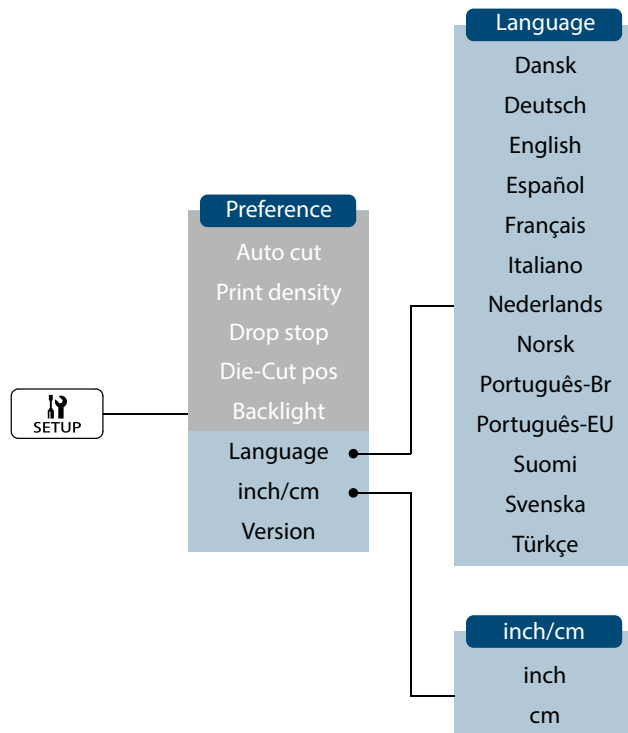

menu
continues
backward



Top

Specifications

Using the printer with
Easy-Mark Plus

Troubleshooting

Part Names and
Functions

Start Here

Cleaning

Initializing the
Settings

Label Functions

Key Menu Index

Frame and Table Lists

Symbol List

Technical Support

File Storage Menu

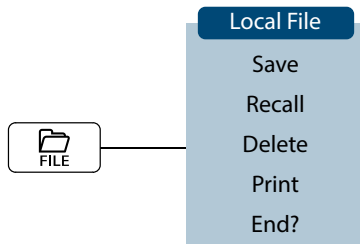

Top

Specifications

Using the printer with
Easy-Mark Plus

Troubleshooting

Part Names and
Functions

Start Here

Cleaning

Initializing the
Settings

Label Functions

Key Menu Index

Frame and Table Lists

Symbol List

Technical Support

Accent

A	Á À Â Ã Ä Å Æ Ā Ą Ă
C	Ç Ć Ć Ć
D	Đ Ď
E	É È Ě Ê Ę Æ Ø Ē Ę Ę Ě
G	Ĝ Ğ Ğ Ğ
H	Ĥ
I	Í Î Ĩ Ì Ĭ Ī Ĳ Ĳ Ĳ
K	Ķ
L	Ł Ł Ł Ł Ł
N	Ñ Ñ Ñ Ñ Ñ Ñ
O	Ó Ô Œ Õ Ò Ö Ø Ő Ō Ő
P	Ɔ
R	Ř Ř
S	Š Š Š
T	Ť Ť Ť
U	Ú Ü Ù Û Ü Ū Ū Ū Ū
W	Ŵ
Y	Ý Ÿ Ÿ
Z	Ž Ž Ž Ʒ

a	á à â ã ä å æ ą ā ą ą
c	ç ć Ć Ć
d	đ đ đ'
e	é è ě ê ę æ ē ę è ě
g	ğ ğ ğ
h	ħ
i	í î ĩ ì Ĳ Ī Ĳ Ĳ
k	ķ
l	ł ł ł ł ł
n	ñ ñ ñ ñ ñ ñ
o	ó ô œ õ ò ö ø ő ō ő
p	Ɔ
r	ř ř
s	š š š š š
t	ť ť ť
u	ú ü ù û ū ū ū ū
w	ŵ
y	ý Ÿ Ÿ
z	ž ž ž Ʒ
?	¿
!	!

Top

Specifications

Using the printer with
Easy-Mark Plus

Troubleshooting

Part Names and
Functions

Start Here

Cleaning

Initializing the
Settings

Label Functions

Key Menu Index











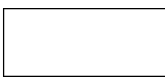

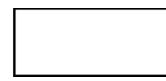
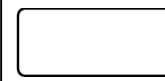

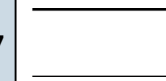

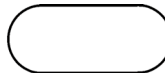
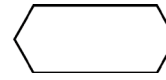
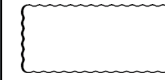
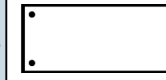
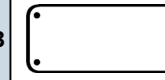
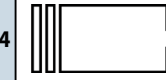
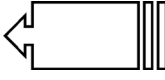
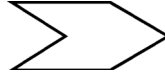
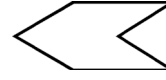
Frame and Table Lists

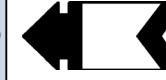
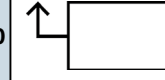
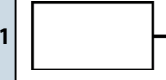
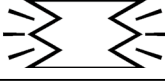
Symbol List

Technical Support

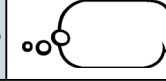
Frame and Table Lists

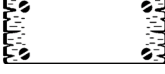
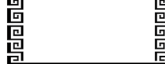
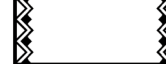
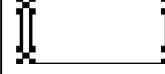
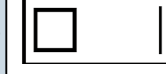
Frame

1		2		3		4		5		6		7	
8		9		10		11		12		13		14	
15		16		17		18		19		20		21	
22		23		24		25		26		27		28	
29		30		31		32		33		34		35	

Top

Specifications

Using the printer with
Easy-Mark Plus

Troubleshooting

Part Names and
Functions

Start Here

Cleaning

Initializing the
Settings

Label Functions







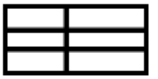
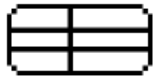

Key Menu Index

Frame and Table Lists

Symbol List

Technical Support

Table

1		2		3		4		5		6		7	
8		9		10									

Top

Specifications

Using the printer with Easy-Mark Plus

Troubleshooting

Part Names and Functions

Start Here

Cleaning

Initializing the Settings

Label Functions

Key Menu Index

Frame and Table Lists

Symbol List

Technical Support

■ **Number**

① ② ③ ④ ⑤ ⑥ ⑦ ⑧ ⑨ ⑩ ⑪ ⑫ ⑬ ⑭ ⑮ ⑯ ⑰ ⑱ ⑲ ⑳ ○ — 二
 ≡ I II III IV V VI VII VIII IX X i ii iii iv v vi vii viii ix x ^{1 2}
 3 4 5 6 7 8 9 0 1 2 3 4 5 6 7 8 9 0 1/3 2/3

■ **Office**



■ **PPE**



■ **Prohibition**



■ **Public signs**



■ **Punctuation**

… · · № © ® € TEL FAX ¶ ` ™ • ´ ¨ ~ § ♂ ♀ ° • † ‡

■ **Shipping**



■ **Warning**



■ **Extra symbol**



Top

Specifications

Using the printer with Easy-Mark Plus

Troubleshooting

Part Names and Functions

Start Here

Cleaning

Initializing the Settings

Label Functions

Key Menu Index

Frame and Table Lists

Symbol List

Technical Support

Technical Support Contact information: phone #, email. address

Additional Support

Visit www.panduit.com

Free Downloads

Path: Support / Download Center / Software
Firmware Printers

- Detailed Operator's Manual
- Replacement Quick Reference Card
- Product Bulletin
- Product specification and safety information.

Warranty Registration

Path: Support / Product Registration

Related Products

- MP Label Cassettes
- MP100 Printer
- Mobile Labeling Apps for Android and iOS
- Easy-Mark Plus Labeling Software

Global Customer Service

- cs@panduit.com
- U.S. and Canada: 800-777-3300
- Europe, Middle East, and Africa: 44.20.8601.7200
- Latin America: 52.33.3777.6000
- Asia Pacific: 65.6305.7575

PANDUIT TECHNICAL SUPPORT

1-866-871-4571

GA-TECHSUPPORT@PANDUIT.COM

MP300 Label Printer
Imprimante d'étiquettes

AC adapter / Adaptateur secteur : AST1527Z2-1
15V == 2.7A
Alkaline batteries(AA size×6) / Piles alcalines(AA Taille×6)
9V == 2.7A

CAN ICES-3(B) / NMB-3(B)

In case of alkaline battery
RATED OPERATING TIME / RATED RESTING TIME: 0.5H / 1.0H
En cas de pile alcaline
TEMPS DE FONCTIONNEMENT NOMINALE /
TEMPS DE REPOS NOMINALE : 0,5H / 1,0H
This device complies with part 15 of the FCC Rules. Operation is
subject to the following two conditions:
(1) This device may not cause harmful interference, and
(2) this device must accept any interference received,
including interference that may cause undesired
operation.

PANDUIT

Panduit Corp.
World Headquarters
Tinley Park, IL 60487
800.777.3300
www.panduit.com

Made in CHINA / Fabriqué en CHINE
Use only power supplies listed in the user instructions.
Utiliser l'adaptateur secteur indiqué dans le guide de l'utilisateur.

181372700

BC, FC, CE, and warning symbols are also present on the label.

Top

Specifications

Using the printer with
Easy-Mark Plus

Troubleshooting

Part Names and
Functions

Start Here

Cleaning

Initializing the
Settings

Label Functions

Key Menu Index

Frame and Table Lists

Symbol List

Technical Support